

Polio Eradication Initiative, Afghanistan

AFP Surveillance Report Week 07

(Ending on 19 February 2022)

National Surveillance Cell

22 February 2022

Total AFP Cases Reported in 2021 = 4,086

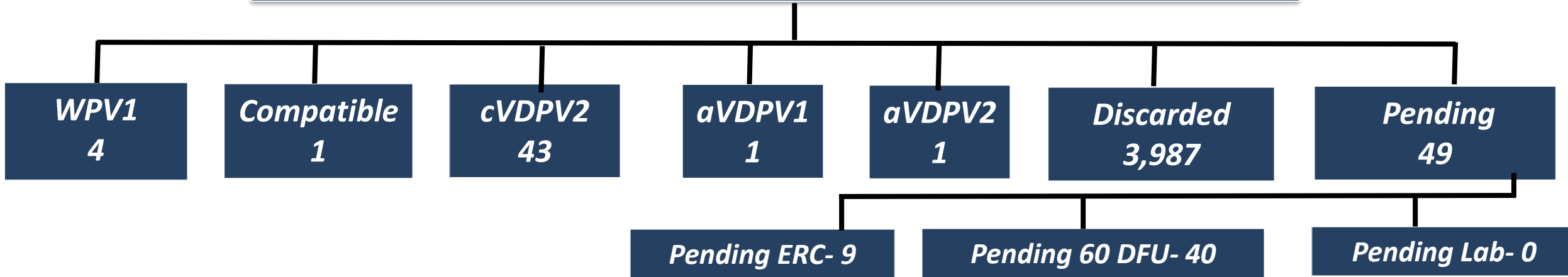

Region	2021								2022							
	WPV1	Comp	cVDPV2	aVDPV2	aVDPV1	Discarded	Pending	Total	WPV1	Comp	cVDPV2	aVDPV2	aVDPV1	Discarded	Pending	Total
South	0	1	12	0	0	803	11	827	0	0	0	0	0	43	45	88
East	0	0	0	0	0	568	4	572	0	0	0	0	0	46	36	82
Southeast	1	0	8	0	0	370	9	388	1	0	0	0	0	38	17	56
West	0	0	17	0	0	610	3	630	0	0	0	0	0	33	20	53
Northeast	3	0	0	0	0	393	12	408	0	0	0	0	0	33	16	49
Badakshan	0	0	0	0	0	89	0	89	0	0	0	0	0	5	2	7
Central	0	0	4	1	1	834	3	843	0	0	0	0	0	55	23	78
North	0	0	2	0	0	320	7	329	0	0	0	0	0	23	17	40
Country	4	1	43	1	1	3,987	49	4,086	1	0	0	0	0	276	176	453

WPV1, Compatible and VDPV Cases

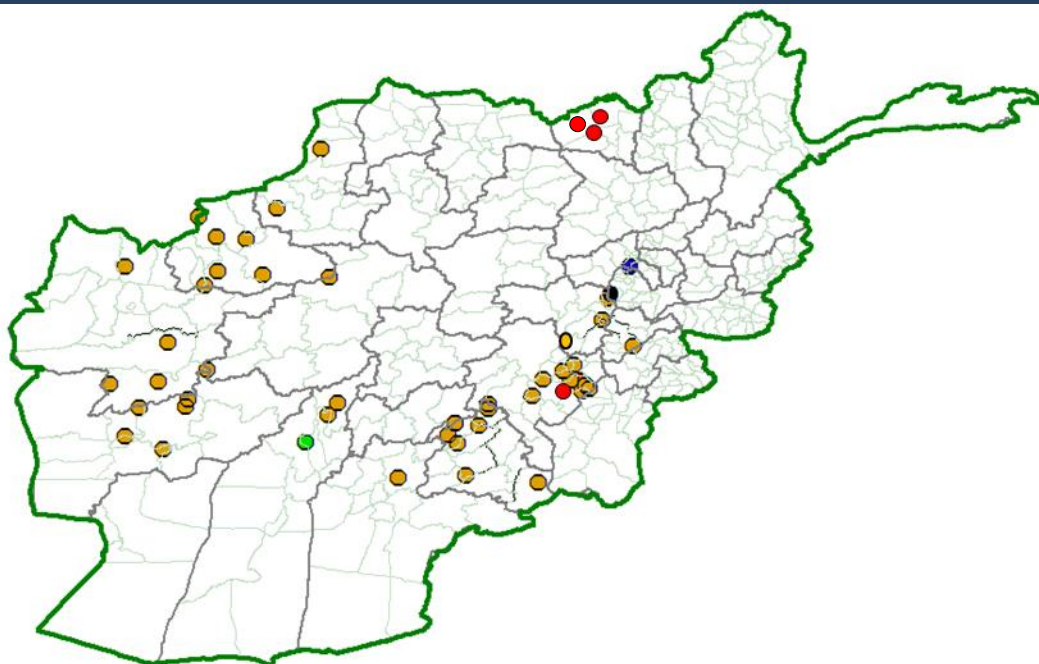

2021
 WPV1 -04
 Compatible- 01
 cVDPV2- 43
 aVDPV2- 01
 aVDPV3- 01
 aVDPV1- 0

- WPV1
- Comp
- cVDPV2
- aVDPV2
- aVDPV3
- aVDPV1

2022
 WPV1 – 01
 Compatible- 0
 cVDPV2 - 0
 aVDPV2 - 0
 aVDPV1- 0

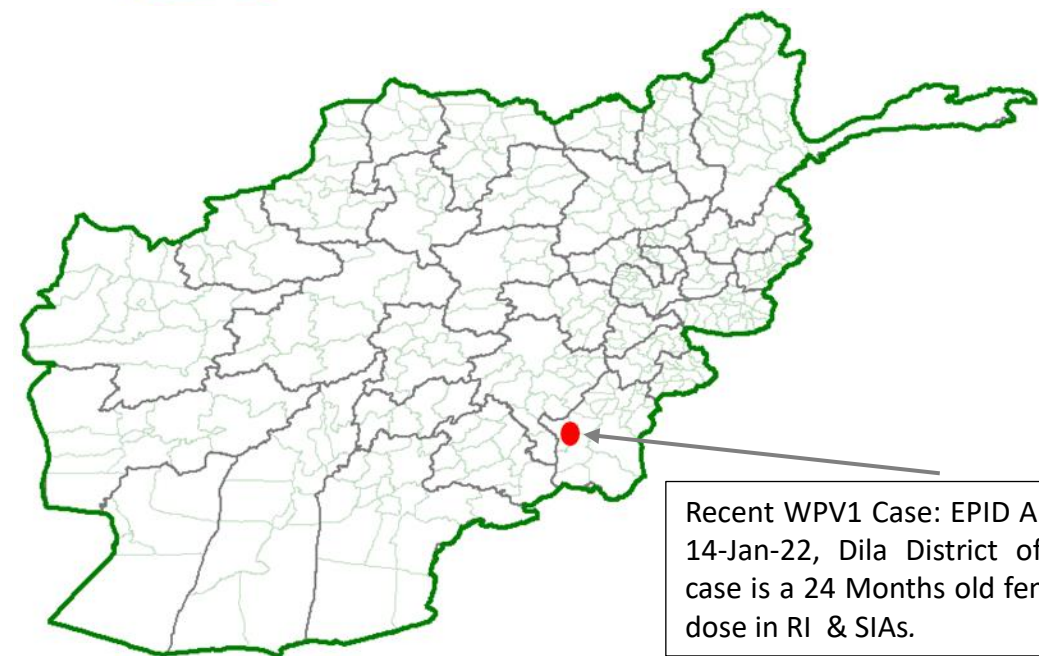

Recent WPV1 Case: EPID AFG/07/22/026, DONSET-14-Jan-22, Dila District of Paktika Province. The case is a 24 Months old female child with zero OPV dose in RI & SIAs.

WPV1 Cases / Infected districts

Province	2021		2022		Date of onset of Last polio case
	No. WPV1 Cases	No. infected districts	No. WPV1 Cases	No. infected districts	
Badakhshan	0	0	0	0	0
Badghis	0	0	0	0	0
Baghlan	0	0	0	0	0
Balkh	0	0	0	0	0
Farah	0	0	0	0	0
Ghazni	1	1	0	0	0
Hilmand	0	0	0	0	0
Hirat	0	0	0	0	0
Kandahar	0	0	0	0	0
Khost	0	0	0	0	0
Kunar	0	0	0	0	0
Laghman	0	0	0	0	0
Nimroz	0	0	0	0	0
Paktika	0	0	1	1	14-Jan-22
Uruzgan	0	0	0	0	0
Zabul	0	0	0	0	0
Kunduz	3	1	0	0	0
Total	4	2	1	1	14-Jan-22

WPV1 Cases by month of onset and SIAs intervention

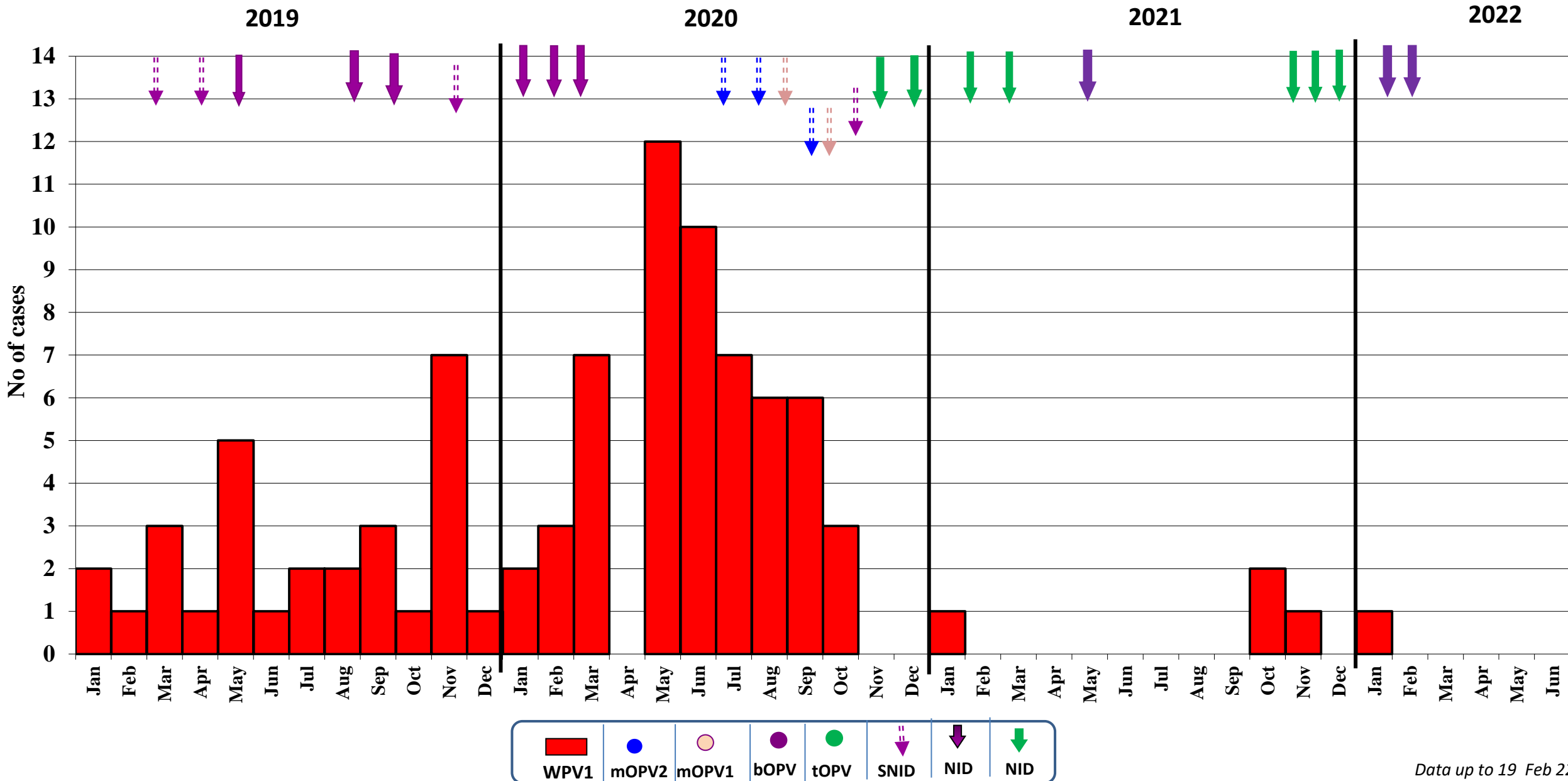

List of Compatible Polio Cases, 2021

S.No	EPID	Province	District	Onset	Sex	Age (m)	NO. OPV Doses		DT. Last OPV Dose	DT. Stool
							RI	SIAS		
1	AFG/08/20/028	Hilmand	Musaqalah	01-Jan-21	M	36	0	0	-	17-Jan-21

List of WPV1 Cases, 2021

S.N.S	EPID	Province	District	Onset	Sex	Age (m)	NO. OPV Doses		DT. Last OPV Dose	DT. Stool	Genetics	
							RI	SIAS			Cluster	Linkage
1	AFG/07/21/001	Ghazni	Andar	01-01-21	M	18	2	1	-	03-01-21	YB3C	99.33% with PAK20-ENV420E1 PAK/BN/QTA/RP-1/20/007 QUETTA 99.23% with PAK20-ENV412E1 PAK/BN/QTA/JT-1/20/006 QUETTA
2	AFG/01/21/325	Kunduz	Emamsaheb	20-10-21	M	25	0	1	16-06-21	02-11-21	YB3A	98.89% WITH AFG20-ENV267E5 AFG/NE/KDZ/NML-1/20/009 KUNDUZ 98.89% WITH PAK20-ENV743E3 PAK/KP/DIK/BM-1/20/011 DI KHAN
3	AFG/01/21/327	Kunduz	Emamsaheb	29-10-21	F	10	0	1	-	02-11-21	YB3A	97.57% WITH AFG20-ENV267E5 AFG/NE/KDZ/NML-1/20/009 KUNDUZ 97.57% WITH PAK20-ENV743E3 PAK/KP/DIK/BM-1/20/011 DI KHAN
4	AFG/01/21/349	Kunduz	Emamsaheb	11-11-21	M	24	0	1	10-11-21	21-11-21	YB3A	99.89% WITH AFG21-4148 AFG/01/21/327 KUNDUZ 97.46% WITH AFG20-ENV267E5 AFG/NE/KDZ/NML-1/20/009 KUNDUZ

 Reported during this week

Data up to 19 Feb 22

List of WPV1 Cases, 2022

S.No	EPID	Province	District	Onset	Sex	Age (m)	NO. OPV Doses		DT. Last OPV Dose	DT. Stool	Genetics	
							RI	SIAS			Cluster	Linkage
1	AFG/07/22/026	Paktika	Dila	14-01-22	F	24	0	0	-	23-01-22	YB3C	99.22% WITH PAK20-ENV607E2 PAK/BN/QTA/TA-1/20/009 QUETTA 99.11% WITH PAK20-ENV650E1 PAK/BN/QTA/TA-1/20/010 QUETTA

 Reported during this week

Data up to 19 Feb 22

List of VDPV Cases, 2021 (1/2)

S.No	EPID	Province	District	Onset	Sex	Age (m)	NO. OPV Doses		DT. Last OPV Dose	DT. Stool	Sequencing Results	Classification	Emergence
							RI	SIAS					
1	AFG/08/21/016	ZABUL	ARGHANDAB	07-01-21	M	9	0	0	-	13-01-21	VDPV2	cVDPV2	Pakistan, Gilgit Baltistan-1
2	AFG/07/21/010	GHAZNI	ANDAR	08-01-21	M	9	0	0	-	11-01-21	VDPV2	cVDPV2	Pakistan, Gilgit Baltistan-1
3	AFG/03/21/019	BADGHIS	QADIS	12-01-21	M	10	0	0	12-09-20	18-01-21	VDPV2	cVDPV2	Pakistan, Gilgit Baltistan-1
4	AFG/03/21/006	FARAH	BALABULUK	02-01-21	M	7	0	0	-	09-01-21	VDPV2	cVDPV2	Pakistan, Gilgit Baltistan-1
5	AFG/03/21/003	FARAH	BALABULUK	01-01-21	M	10	0	1	-	07-01-21	VDPV2	cVDPV2	Pakistan, Gilgit Baltistan-1
6	AFG/03/21/017	BADGHIS	BALAMURGHAB	12-Jan-21	M	20	0	1	01-12-20	17-01-21	VDPV2	cVDPV2	Pakistan, Gilgit Baltistan-1
7	AFG/08/21/046	HILMAND	BAGHRAN	05-01-21	F	26	0	0	-	31-01-21	VDPV2	cVDPV2	Pakistan, Gilgit Baltistan-1
8	AFG/08/21/037	ZABUL	DAYCHOPAN	23-01-21	F	36	2	4	02-04-19	29-01-21	VDPV2	cVDPV2	AFG-NGR-1
9	AFG/07/21/032	GHAZNI	QARABAGH	24-01-21	M	26	0	4	-	31-01-21	VDPV2	cVDPV2	Pakistan, Gilgit Baltistan-1
10	AFG/03/21/028	FARAH	KHAK-E-SAFED	17-01-21	M	8	1	1	18-06-20	23-01-21	VDPV2	cVDPV2	Pakistan, Gilgit Baltistan-1
11	AFG/02/21/027	FARYAB	QAYSAR	28-01-21	M	18	3	5	30-11-20	02-02-21	VDPV2	cVDPV2	AFG-HLD-1
12	AFG/08/21/066	ZABUL	QALAT	04-02-21	F	36	0	7	16-11-19	10-02-21	VDPV2	cVDPV2	Pakistan, Gilgit Baltistan-1
13	AFG/07/21/049	GHAZNI	GIRO	07-02-21	F	10	2	1	15-01-21	12-02-21	VDPV2	cVDPV2	AFG-NGR-1
14	AFG/07/21/031	GHAZNI	WAGHAZ	25-01-21	M	18	4	2	-	29-01-21	VDPV2	cVDPV2	AFG-NGR-1
15	AFG/07/21/012	GHAZNI	GHAZNI	04-01-21	M	42	5	7+	02-12-20	13-01-21	VDPV2	cVDPV2	Pakistan, Gilgit Baltistan-1
16	AFG/03/21/038	BADGHIS	BALAMURGHAB	24-01-21	M	24	4	3	30-11-20	28-01-21	VDPV2	cVDPV2	Pakistan, Gilgit Baltistan-1
17	AFG/03/21/010	BADGHIS	BALAMURGHAB	08-01-21	M	13	0	0	-	15-01-21	VDPV2	cVDPV2	AFG-NGR-1
18	AFG/08/21/093	KANDAHAR	SHAHWALIKOT	16-02-21	F	20	1	0	-	24-02-21	VDPV2	cVDPV2	AFG-NGR-1
19	AFG/05/21/152	LOGAR	PUL-E- ALAM	19-02-21	M	18	2	0	23-07-19	02-03-21	VDPV2	cVDPV2	AFG-NGR-1
20	AFG/03/21/105	FARAH	FARAH	24-02-21	M	10	2	0	15-06-20	01-03-21	VDPV2	cVDPV2	Pakistan, Gilgit Baltistan-1
21	AFG/08/21/105	ZABUL	SHOMULZAY	22-02-21	M	18	0	2	-	01-02-21	VDPV2	cVDPV2	Pakistan, Gilgit Baltistan-1
22	AFG/03/21/098	HIRAT	SHINDAND	20-02-21	M	9	0	0	-	01-03-21	VDPV2	cVDPV2	AFG-NGR-1
23	AFG/05/21/164	WARDAK	MAYDANSHAHR	3-03-21	M	10	5	0	23-02-21	07-03-21	VDPV2	cVDPV2	AFG-NGR-1
24	AFG/05/21/175	KABUL	PAGHMAN	22-02-21	M	12	2	2	-	08-03-21	VDPV1	aVDPV1	aVDPV1
25	AFG/05/21/158	PARWAN	CHARIKAR	01-03-21	M	48	5	7+	18-01-21	05-03-21	VDPV2	aVDPV2	aVDPV2

List of VDPV Cases, 2021 (2/2)

S.No	EPID	Province	District	Onset	Sex	Age (m)	NO. OPV Doses		DT. Last OPV Dose	DT. Stool	Sequencing Results	Classification	Emergence
							RI	SIAS					
26	AFG/08/21/091	ZABUL	KAKAR	25-01-21	M	48	3	5	12-10-19	22-02-21	VDPV2	cVDPV2	Pakistan, Gilgit Baltistan-1
27	AFG/08/21/129	ZABUL	KAKAR	7-03-21	F	36	0	3	25-11-19	12-03-21	VDPV2	cVDPV2	Pakistan, Gilgit Baltistan-1
28	AFG/08/21/123	ZABUL	DAYCHOPAN	2-03-21	M	18	2	0	-	11-03-21	VDPV2	cVDPV2	AFG-NGR-1
29	AFG/03/21/123	BADGHIS	QADIS	10-03-21	M	96	5	7+	-	13-03-21	VDPV2	cVDPV2	AFG-NGR-1
30	AFG/08/21/122	ZABUL	DAYCHOPAN	18-02-21	M	19	0	1	25-11-19	12-03-21	VDPV2	cVDPV2	AFG-NGR-1
31	AFG/03/21/131	HIRAT	ADRASKAN	4-02-21	F	24	2	4	18-01-21	16-03-21	VDPV2	cVDPV2	Pakistan, Gilgit Baltistan-1
32	AFG/07/21/081	GHAZNI	ANDAR	15-03-21	M	24	1	0	-	19-03-21	VDPV2	cVDPV2	AFG-NGR-1
33	AFG/08/21/152	HILMAND	KAJAKI	11-03-21	M	14	0	0	-	20-03-21	VDPV2	cVDPV2	Pakistan, Gilgit Baltistan-1
34	AFG/07/21/083	GHAZNI	QARABAGH	14-03-21	F	42	3	4	-	21-03-21	VDPV2	cVDPV2	Pakistan, Gilgit Baltistan-1
35	AFG/03/21/156	HIRAT	KUSHK	18-03-21	M	30	0	4	18-01-21	26-03-21	VDPV2	cVDPV2	AFG-NGR-1
36	AFG/03/21/217	FARAH	PUSHTROD	16-04-21	F	14	0	5	17-02-21	19-04-21	VDPV2	cVDPV2	Pakistan, Gilgit Baltistan-1
37	AFG/03/21/214	HIRAT	SHINDAND	11-04-21	M	11	0	1	30-03-21	19-04-21	VDPV2	cVDPV2	Pakistan, Gilgit Baltistan-1
38	AFG/03/21/205	HIRAT	SHINDAND	09-04-21	M	12	4	0	15-02-21	15-04-21	VDPV2	cVDPV2	Pakistan, Gilgit Baltistan-1
39	AFG/05/21/285	WARDAK	SAYDABAD	22-04-21	M	30	5	0	22-01-20	26-04-21	VDPV2	cVDPV2	Pakistan, Gilgit Baltistan-1
40	AFG/02/21/092	FARYAB	DAWLATABAD	26-03-21	M	13	4	0		19-04-21	VDPV2	cVDPV2	Pakistan, Gilgit Baltistan-1
41	AFG/08/21/267	ZABUL	DAYCHOPAN	04-04-21	F	12	0	0	-	28-04-21	VDPV2	cVDPV2	AFG-NGR-1
42	AFG/03/21/259	BADGHIS	JAWAND	29-04-21	M	14	1	0	15-11-20	11-05-21	VDPV2	cVDPV2	Pakistan, Gilgit Baltistan-1
43	AFG/07/21/152	GHAZNI	ANDAR	12-05-21	F	42	3	7+	-	19-05-21	VDPV2	cVDPV2	Pakistan, Gilgit Baltistan-1
44	AFG/03/21/324	BADGHIS	JAWAND	09-06-21	M	50	2	7+	02-04-19	14-06-21	VDPV2	cVDPV2	Pakistan, Gilgit Baltistan-1
45	AFG/05/21/468	WARDAK	SAYDABAD	09-07-21	F	42	5	2	21-06-21	11-07-21	VDPV2	cVDPV2	Pakistan, Gilgit Baltistan-1

 Reported during last week

Details of Environmental Surveillance Sites

2013: Started in Kandahar
 2014: Helmand, Kabul and Nangarhar, Kunar (Mandacool)
 2015: Nangarhar (Behsud- Hada Farm), Kandahar city (Loyawala)
 2016: Kandahar (Karwan Kocho)
 2017: Nangarhar , Khost, Herat, Balkh (Mazar e Sharif) and Kunduz
 2018: remain the same
 2019: Increased one site in Nangarhar (Batikot district)
 2020: Increased one site in Paktia (Gardez district)
 2020: Increased one site in Laghman (Mehterlam district)
 2021: Increased one site in Ghazni (Ghazni City)
 2021: Increased one site in Uruzgan (Tirinkot City)
 2021: Increased one site in Kunduz (Kunduz city)

Total Sites: 26

Province	District	Site. Name	Start Date	Date Recent WPV1 Isolate	
Kandahar	Kandahar	Khandak	Sep-13	9-Jul-20	
		Rarobat	Sep-13	27-Sep-20	
		Loya Wala	Oct-15	25-Feb-20	
		Karwan Kocho	Dec-16	6-Dec-20	
Hilmand	Lashkargah	Bolan Bridge	Feb-14	23-Feb-21	
		Radio Mahallie	Feb-14	6-Sep-20	
	Nahr-e-Siraj	Zarat Bagh	Sep-14	24-Aug-20	
Baran Sarai		May-15	27-Apr-20		
Uruzgan	Tirinkot	Sahibzada Khel	Oct-21	None	
Nangarhar	Jalalabad	Radar Bridge	Mar-14	11-Dec-19	
		Sangi Qala	Mar-14	8-Jan-20	
		Ulfat Mena	Jan-17	6-Oct-20	
		Behsud	Hada Farm	Aug-15	25-Oct-18
Kunar	Asadabad	Manz Kalay	Jul-19	25-Jul-20	
Laghman	Mehterlam	Mandacool	Dec-14	25-Sep-18	
Kabul	Kabul	Gumeen	Jul-20	None	
		Qila-e-Zaman Khan	Jan-14	26-Jun-18	
		Karta-e-Naw	Jan-14	26-Jun-18	
Paktia	Gardez	Khwaja Bughra	Jan-14	26-Sep-20	
Khost	Matun	Dawlatzai	Feb-20	None	
Ghazni	Ghazni	Hindu Kot	Jan-17	25-Apr-20	
Herat	Herat	Tarkary Market	Jul-21	None	
Balkh	Herat	Payen Aab	Jun-17	25-Jul-20	
Kunduz	Mazar-e-Sharif	Dawlatabad	Jul-17	None	
		Kunduz	Noormahal	Aug-17	27-Sep-20
		Kunduz	Asia Shirkat (Nahia 3)	Dec-21	None

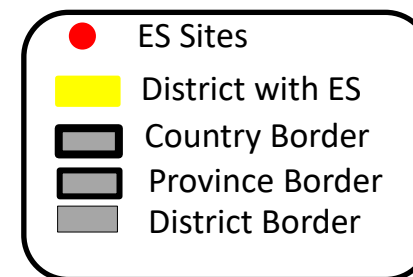
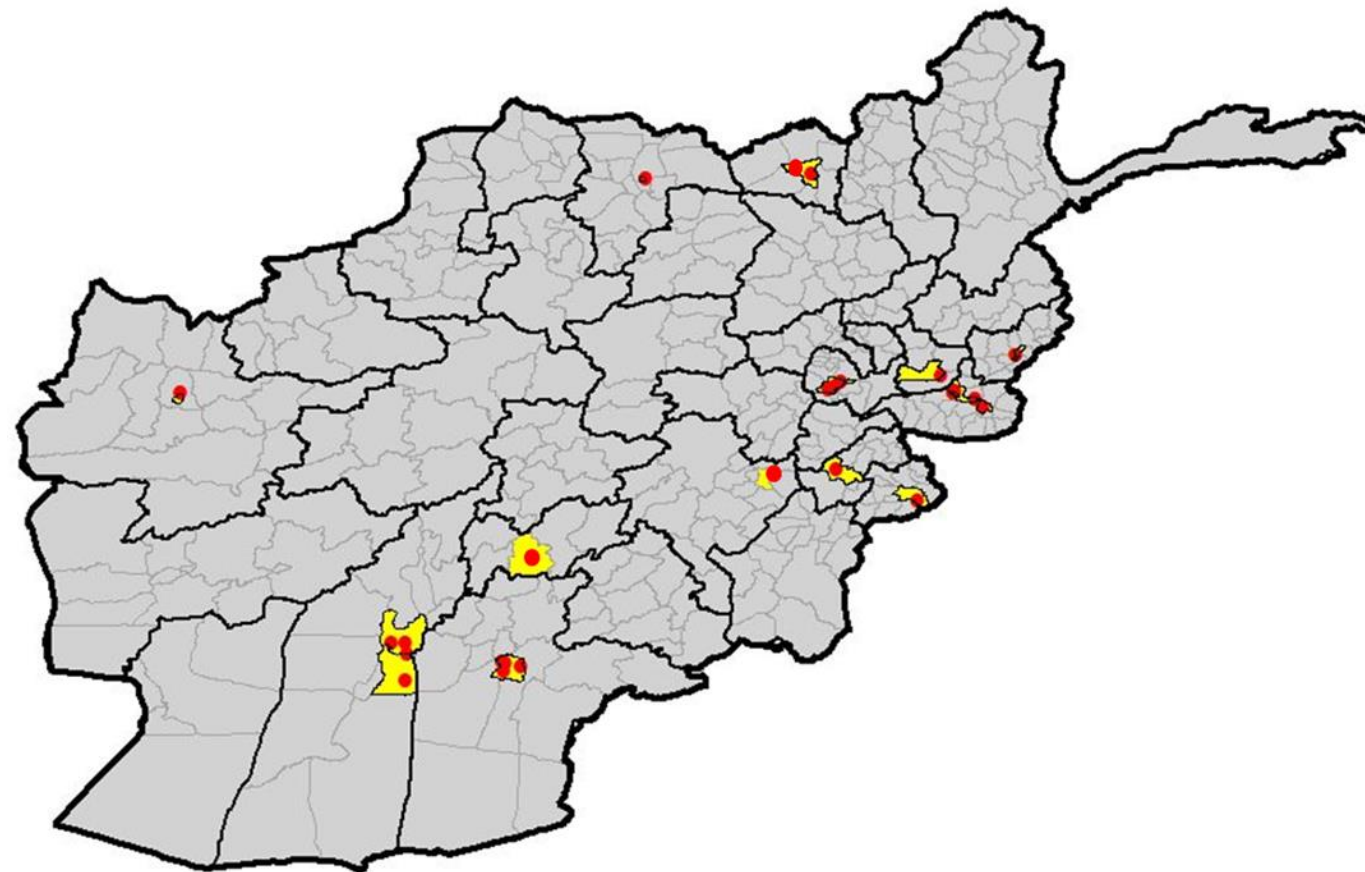

Summary of Laboratory data for Environmental Surveillance, (2020- 2022 to date)

S/N	Site	Total Samples 2020 - to date	Environmental Samples Collection Frequency																																															
			Jan-1	Jan-2	Feb-1	Feb-2	Mar-1	Mar-2	Apr-1	Apr-2	May-1	May-2	Jun-1	Jun-2	Jul-1	Jul-2	Aug-1	Aug-2	Sep-1	Sep-2	Oct-1	Oct-2	Nov-1	Nov-2	Dec-1	Dec-2	Jan-1	Jan-2	Feb-1	Feb-2	Mar-1	Mar-2	Apr-1	Apr-2	May-1	May-2	Jun-1	Jun-2	Jul-1	Jul-2	Aug-1	Aug-2	Sep-1	Sep-2	Oct-1	Oct-2	Nov-1	Nov-2	Dec-1	Dec-2
Kandahar Province			168																																															
Kandahar city																																																		
1	KDH-Khandak	42																																																
2	KDH-Rarobat	42																																																
3	KDH-Loya wiala	42																																																
4	KDH- Karwan Kocho	42																																																
Hilmand Province			169																																															
Lashkargah city																																																		
1	LSK-Bolan Bridge	43																																																
2	LSK-Radio Mahalle	42																																																
Nahr-e-Siraj District																																																		
3	Nahr-e-Siraj-Zarat Bagh	42																																																
4	Nahr-e-Siraj-Baran Sarai	42																																																
Uruzgan Province			9																																															
Tirinkot city																																																		
1	Sahibzadakhel	9																																																
Nangarhar Province			255																																															
Jalalabad City																																																		
1	J-abad-Radar Br	51																																																
2	J-abad-Sangi Qala	51																																																
3	J-abad-Ulfat Mena	51																																																
Behsud District																																																		
4	Behsud- Hada Farm	51																																																
Batikot District																																																		
5	Manz Kalay	51																																																
Kunar Province			51																																															
Asadabad city																																																		
1	Mandacool	51																																																
Laghman Province			38																																															
Mehterlam city																																																		
1	Gumeen	38																																																
Kabul Province			108																																															
Kabul city																																																		
1	Qila-e-Zaman K	36																																																
2	Karta-e-Naw	36																																																
3	Khawaja Bughra	36																																																
Khost Province			33																																															
Matun city																																																		
1	Hindu Kot	33																																																
Paktia Province			32																																															
Gardez city																																																		
1	Dawlatzai	32																																																
Ghazni Province			12																																															
Ghazni city																																																		
1	Tarkary Market	12																																																
Hirat Province			33																																															
Hirat City																																																		
1	Payan Aab	33																																																
Balkh Province			27																																															
Mazar City																																																		
1	Dawlatabad	27																																																
Kunduz Province			30																																															
Kunduz City																																																		
1	Noormahal	27																																																
2	Asia Shirkat	3																																																
Afghanistan			965																																															
WPV +ve				413 35 (10%)														478 1 (1%)														74 0																		

Total Sites	26
WPV	36
EV	263
SL1/SL2/SL3	219
EV+SL1/SL2/SL3	153
SL2	54
NVI	17
cVDPV2	213
aVDPV2	5
Under Process	12



Year	Kandahar	Helmand	Nangarhar	Kabul	Hirat	Khost	Kunduz	Total
2020	13	11	4	1	4	1	1	35
2021	0	1	0	0	0	0	0	1
2022	0	0	0	0	0	0	0	0

Ad-hoc sites; Environmental Surveillance Results, East Region, 2022

S/N	Ad hoc Sites		Environmental Samples (Ad hoc Sites) Collection Frequency															
			Feb-1	Feb-2	Mar-1	Mar-2	Apr-1	Apr-2	May-1	May-2	Jun-1	Jun-2	Jul-1	Jul-2				
			22		22		22		22		22		22					
Kunar Province		2																
Asadabad city																		
1	KNR/KZK-1 (Kuz Kuruna)	2																
Laghman Province		2																
Mehterlam city																		
2	LAG/SKQ-1 (Shekhano Qala)	2																
Nangarhar Province		2																
Behsud District																		
3	NGR/KNK-1 (Kunaryano Kocha)	2																
East Region		6																
WPV +ve																		

WPV1 ■ cVDPV2 ■ aVDPV ■ EV ■ SL2 ■ EV+SL1/SL3/SL2 ■ NEG ■ SL1/SL2/SL3 ■ UP ■

Total Ad hoc Sites	3
WPV	0
EV	1
SL1/SL2/SL3	2
EV+SL1/SL2/SL3	0
SL2	0
Neg	0
cVDPV2	0
aVDPV2	0
Under Process	3
Total	6

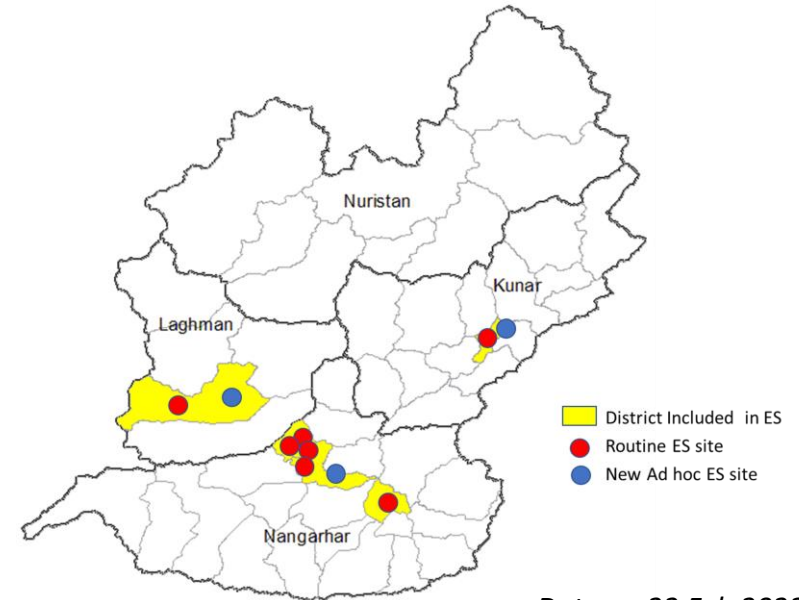

Data up 22 Feb 2022

Genetic Sequencing Results of Sewage WPV1 Isolates, 2021

SN	Province	Collection Site	Epid. No.	Collection date	Cluster	Sequence Analysis
1	Helmand	Bolan Bridge	AFG/SR/HLD/BLB-1/21/004	23-Feb-21	R4B5C5B2B3	98.45% WITH PAK19-ENV246RD PAK/BN/QTA/RP-1/19/005 QUETTA

List of VDPV2 (c and a) isolates (Env) 2021 (1/2)

S/N	Province	District	Epid#	Site	Collection Date	Classification	Emergence
1	NANGARHAR	BATIKOT	AFG/ER/NGR/MZK-1/21/001	MANZ KALAY	5-Jan-21	cVDPV2	Pakistan, Gilgit Baltistan-1
2	KANDAHAR	KANDAHAR	AFG/SR/KDH/RBT-1/21/001	RAROBAT	5-Jan-21	cVDPV2	AFG-NGR-1
3	KANDAHAR	KANDAHAR	AFG/SR/KDH/KWK-1/21/001	KARWAN KOCHA	5-Jan-21	cVDPV2	AFG-NGR-1
4	KANDAHAR	KANDAHAR	AFG/SR/KDH/KDK-1/21/001	KHANDAK	5-Jan-21	cVDPV2	AFG-NGR-1
5	KANDAHAR	KANDAHAR	AFG/SR/KDH/LWL-1/21/001	LOYA WIALA	5-Jan-21	cVDPV2	AFG-NGR-1
6	HILMAND	NAHR-E-SARAJ	AFG/SR/HLD/ZTB-1/21/001	ZARAT BAGH	4-Jan-21	cVDPV2	AFG-NGR-1
7	HILMAND	LASHKARGAH	AFG/SR/HLD/RDM-1/21/001	RADIO MAHALLIE	5-Jan-21	cVDPV2	AFG-NGR-1
8	HILMAND	LASHKARGAH	AFG/SR/HLD/BLB-1/21/001	BOLAN BRIDGE	5-Jan-21	cVDPV2	AFG-NGR-1
9	HILMAND	NAHR-E-SARAJ	AFG/SR/HLD/BSR-1/21/001	BARAN SARAI	4-Jan-21	cVDPV2	Pakistan, Gilgit Baltistan-1
10	KANDAHAR	KANDAHAR	AFG/SR/KDH/KDK-1/21/002	KHANDAK	26-Jan-21	cVDPV2	AFG-NGR-1
11	, KANDAHAR	KANDAHAR	AFG/SR/KDH/KWK-1/21/002	KARWAN KOCHA	26-Jan-21	cVDPV2	AFG-NGR-1
12	HILMAND	LASHKARGAH	AFG/SR/HLD/BLB-1/21/002	BOLAN BRIDGE	26-Jan-21	cVDPV2	Pakistan, Gilgit Baltistan-1
13	HILMAND	NAHR-E-SARAJ	AFG/SR/HLD/BSR-1/21/002	BARAN SARAI	26-Jan-21	cVDPV2	Pakistan, Gilgit Baltistan-1
14	NANGARHAR	BATIKOT	AFG/ER/NGR/MZK-1/21/003	MANZ KALAY	4-Feb-21	cVDPV2	Pakistan, Gilgit Baltistan-1
15	KANDAHAR	KANDAHAR	AFG/SR/KDH/KWK-1/21/003	KARWAN KOCHA	6-Feb-21	cVDPV2	Pakistan, Gilgit Baltistan-1
16	KANDAHAR	KANDAHAR	AFG/SR/KDH/KDK-1/21/003	KHANDAK	6-Feb-21	cVDPV2	Pakistan, Gilgit Baltistan-1
17	KABUL	KABUL	AFG/CR/KBL/KBG-1/21/003	KHWAJA BUGHRA	3-Feb-21	aVDPV2	aVDPV2
18	HILMAND	LASHKARGAH	AFG/SR/HLD/RDM-1/21/003	RADIO MAHALLIE	4-Feb-21	cVDPV2	Pakistan, Gilgit Baltistan-1
19	HILMAND	NAHR-E-SARAJ	AFG/SR/HLD/BSR-1/21/003	BARAN SARAI	4-Feb-21	cVDPV2	Pakistan, Gilgit Baltistan-1
20	KANDAHAR	KANDAHAR	AFG/SR/KDH/RBT-1/21/003	RAROBAT	06-Feb-21	cVDPV2	AFG-NGR-1
21	KANDAHAR	KANDAHAR	AFG/SR/KDH/LWL-1/21/003	LOYA WIALA	06-Feb-21	cVDPV2	Pakistan, Gilgit Baltistan-1
22	KANDAHAR	KANDAHAR	AFG/SR/KDH/LWL-1/21/004	LOYA WIALA	24-Feb-21	cVDPV2	AFG-NGR-1
23	HILMAND	NAHR-E-SARAJ	AFG/SR/HLD/BSR-1/21/004	BARAN SARAI	23-Feb-21	cVDPV2	AFG-NGR-1
24	KANDAHAR	KANDAHAR	AFG/SR/KDH/RBT-1/21/004	RAROBAT	24-Feb-21	cVDPV2	AFG-NGR-1
25	KUNDUZ	KUNDUZ	AFG/NE/KDZ/NML-1/21/002	NOOR MAHAL	23-Feb-21	cVDPV2	AFG-NGR-1

List of VDPV2 (c and a) isolates (Env) 2021 (2/2)

S/N	Province	District	Epid#	Site	Collection Date	Classification	Emergence
26	HILMAND	LASHKARGAH	AFG/SR/HLD/BLB-1/21/004	BOLAN BRIDGE	23-Feb-21	cVDPV2	AFG-NGR-1
27	HILMAND	NAHR-E-SARAJ	AFG/SR/HLD/ZTB-1/21/004	ZARAT BAGH	23-Feb-21	cVDPV2	AFG-NGR-1
28	KANDAHAR	KANDAHAR	AFG/SR/KDH/KDK-1/21/005	KHANDAK	7-Mar-21	aVDPV2	aVDPV2
29	NANGARHAR	BATIKOT	AFG/ER/NGR/MZK-1/21/005	MANZ KALAY	7-Mar-21	cVDPV2	Pakistan, Gilgit Baltistan-1
30	KANDAHAR	KANDAHAR	AFG/SR/KDH/KWK-1/21/005	KARWAN KOCHA	7-Mar-21	cVDPV2	Pakistan, Gilgit Baltistan-1
31	KABUL	KABUL	AFG/CR/KBL/KTN-1/21/005	KARTI NAW	6-Mar-21	cVDPV2	AFG-NGR-1
32	KANDAHAR	KANDAHAR	AFG/SR/KDH/LWL-1/21/005	LOYA WIALA	7-Mar-21	cVDPV2	AFG-NGR-1
33	KANDAHAR	KANDAHAR	AFG/SR/KDH/RBT-1/21/005	RAROBAT	7-Mar-21	cVDPV2	AFG-NGR-1
34	HILMAND	NAHR-E-SARAJ	AFG/SR/HLD/BSR-1/21/005	BARAN SARAI	6-Mar-2021	cVDPV2	PAK-GB-1
35	HILMAND	LASHKARGAH	AFG/SR/HLD/RDM-1/21/005	RADIO MAHALLIE	7-Mar-2021	cVDPV2	AFG-NGR-1
36	HILMAND	NAHR-E-SARAJ	AFG/SR/HLD/ZTB-1/21/005	ZARAT BAGH	6-Mar-2021	cVDPV2	PAK-GB-1
37	KANDAHAR	KANDAHAR	AFG/SR/KDH/LWL-1/21/006	LOYA WIALA	24-Mar-21	cVDPV2	AFG-NGR-1
38	HERAT	HERAT	AFG/WR/HRT/PYA-1/21/003	PAYAN AB	23-Mar-21	cVDPV2	PAK-GB-1
39	HILMAND	LASHKARGAH	AFG/SR/HLD/RDM-1/21/006	RADIO MAHALLIE	24-Mar-21	cVDPV2	AFG-NGR-1
40	NANGARHAR	BATIKOT	AFG/ER/NGR/MZK-1/21/008	MANZ KALAY	25-Apr-21	cVDPV2	Pakistan, Gilgit Baltistan-1
41	KANDAHAR	KANDAHAR	AFG/SR/KDH/LWL-1/21/007	LOYA WIALA	25-Apr-21	cVDPV2	AFG-NGR-1
42	KANDAHAR	KANDAHAR	AFG/SR/KDH/KWK-1/21/009	KARWAN KOCHA	23-Jun-21	cVDPV2	AFG-NGR-1
43	NANGARHAR	JALALABAD	AFG/ER/NGR/UFM-1/21/014	ULFAT MENA	25-Jul-21	aVDPV-2	aVDPV-2

 New VDPV2 Env Isolates reported during this week

Monthly Comparison of WPV1 Cases/ Sewage Isolates-Point in Time (1/3)

2021

Jan



NSL1 - 1
NSL1 Sewage - 0

Feb



NSL1 - 0
NSL1 Sewage - 1

Mar



NSL1 - 0
NSL1 Sewage - 0

Apr



NSL1 - 0
NSL1 Sewage - 0

2022



NSL1 - 1
NSL1 Sewage - 0



NSL1 - 0
NSL1 Sewage - 0



NSL1 - 0
NSL1 Sewage - 0



NSL1 - 0
NSL1 Sewage - 0



Monthly Comparison of WPV1 Cases/ Sewage Isolates-Point in Time (2/3)

2021

May

Jun

Jul

Aug



NSL1 - 0
NSL1 Sewage - 0



NSL1 - 0
NSL1 Sewage - 0



NSL1 - 0
NSL1 Sewage - 0



NSL1 - 0
NSL1 Sewage - 0

2022



NSL1 - 0
NSL1 Sewage - 0



NSL1 - 0
NSL1 Sewage - 0



NSL1 - 0
NSL1 Sewage - 0



NSL1 - 0
NSL1 Sewage - 0



Monthly Comparison of WPV1 Cases/ Sewage Isolates-Point in Time (3/3)

2021

Sep



NSL1 - 0
NSL1 Sewage - 0

Oct



NSL1 - 2
NSL1 Sewage - 0

Nov



NSL1 - 1
NSL1 Sewage - 0

Dec



NSL1 - 0
NSL1 Sewage - 0

2022



NSL1 - 0
NSL1 Sewage - 0



NSL1 - 0
NSL1 Sewage - 0



NSL1 - 0
NSL1 Sewage - 0



NSL1 - 0
NSL1 Sewage - 0

Reported AFP Cases by Month

--- @ of 2/100,000 <15 year
 — @ of 1/100,000 <15 year

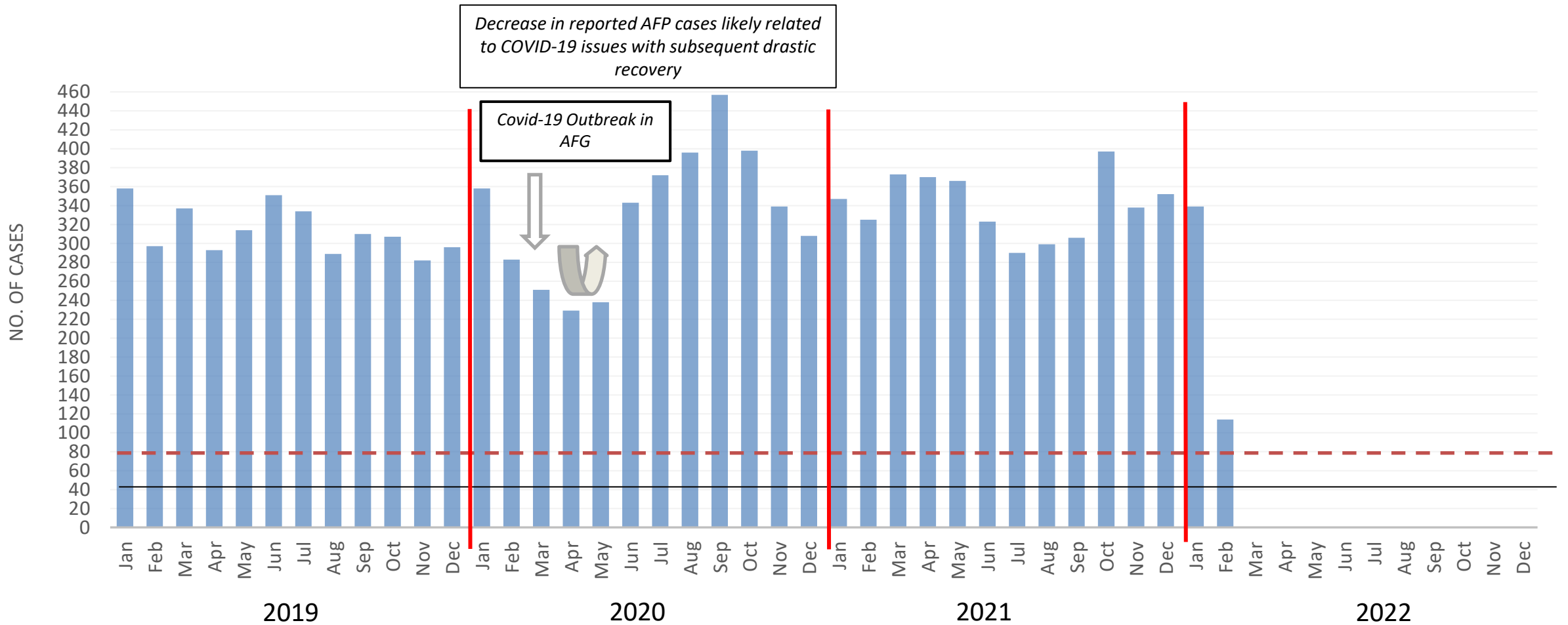

AFP Cases by Week of Onset

Region	AFP Cases		Week Number									
			50	51	52	01	02	03	04	05	06	07
	EXP @ 2	Reported 21	18-Dec-21	25-Dec-21	01-Jan-22	08-Jan-22	15-Jan-22	22-Jan-22	29-Jan-22	05-Feb-22	12-Feb-22	19-Feb-22
South	72	827	18	12	9	9	19	10	17	21	4	1
East	42	572	8	15	13	14	11	16	8	18	13	0
Southeast	42	388	15	4	2	10	13	9	7	10	4	0
West	57	630	7	6	3	10	5	15	7	11	3	0
Northeast	47	408	9	8	9	10	6	14	2	8	5	1
Badakhshan	12	89	3	0	0	2	2	2	1	0	0	0
Central	95	843	12	11	11	12	13	16	17	11	8	0
North	51	329	6	9	3	8	7	8	4	6	4	1
Country	418	4,086	78	65	50	75	76	90	63	85	41	3

Expected @ 2 = Two cases/100,000 <15 yrs

Week (Sun-Sat)

Data up to 19 Feb 22

AFP Cases Labeled Hot & Pending in Lab

EPID	Onset	Province	District	Sex	Age	Doses	DT. Last OPV Dose	D. Stool Collection	Hot by field	Hot by criteria*
AFG/08/22/055	27/01/2022	HILMAND	NAD-E-ALI	M	25	0	17/01/2022	06/02/2022	YES	YES
AFG/08/22/056	29/01/2022	HILMAND	SANGIN	F	14	0	-	03/02/2022	YES	YES
AFG/07/22/048	30/01/2022	KHOST	NADIRSHAHKOT	M	48	0	20/01/2022	07/02/2022	YES	YES
AFG/08/22/077	02/02/2022	HILMAND	KAJAKI	F	48	0	-	08/02/2022	YES	YES
AFG/03/22/048	02/02/2022	BADGHIS	JAWAND	F	36	1	17/01/2022	13/02/2022	YES	YES
AFG/03/22/034	26/01/2022	HIRAT	OBE	F	27	4	17/01/2022	02/02/2022	YES	YES
AFG/06/22/060	03/02/2022	NANGARHAR	DARA-E-NUR	F	40	3	18/01/2022	07/02/2022	YES	YES
AFG/07/22/051	04/02/2022	GHAZNI	GHAZNI	M	18	4	18/01/2022	07/02/2022	YES	YES
AFG/06/22/069	02/02/2022	LAGHMAN	MEHTARLAM	F	18	3	17/01/2022	12/02/2022	YES	YES
AFG/03/22/046	07/02/2022	BADGHIS	QALA-E-NAW	F	34	5	17/01/2022	11/02/2022	YES	YES
AFG/03/22/049	01/02/2022	GHOR	CHAGHCHARAN	M	18	3	31/01/2022	12/02/2022	YES	YES
AFG/03/22/054	03/02/2022	HIRAT	KUSHK	M	36	5	18/01/2022	14/02/2022	YES	YES

* Hot by criteria=AFP cases have (Fever + rapid progress+ Asymmetric paralysis + Age <48 month)

Under Immunized HOT cases

Data up to 19 Feb 22

Zero Dose AFP Cases, 0 - 59 Months 2021 (1/8)

No.	Region	EPID	Province	District	Onset	Village	Age	D. Stool Collection	Adeq	Lab. R	Reason	
											RI	SIAs
1	SOUTH	AFG/08/21/061	NIMROZ	KHASHROD	07-02-21	DILARAM	12	11-02-21	ADEQ	SL1	Lack of community mobilization / tracking / referral	Inaccessible
2	NORTHEAST	AFG/01/21/041	BAGHLAN	BAGHLAN-E-JADID	05-01-21	MULLA KHEL (BAGHLANI JADID)	13	07-02-21	INADEQ	EV	Area in micro plan but NO outreach/mobile services permitted to be conducted / Banned	Inaccessible
3	WEST	AFG/03/21/032	BADGHIS	BALAMURGHAB	18-01-21	BALA MURGHAB	20	26-01-21	ADEQ	SL2	Area in micro plan but NO outreach/mobile services permitted to be conducted / Banned	Inaccessible
4	WEST	AFG/03/21/035	FARAH	BAKWA	20-01-21	GHAZIABAD (BAKWA)	12	24-01-21	ADEQ	SL2	Area in micro plan but NO outreach/mobile services permitted to be conducted / Banned	Inaccessible
5	WEST	AFG/03/21/010	BADGHIS	BALAMURGHAB	08-01-21	MIRANZA'I	13	15-01-21	ADEQ	cVDPV2	Area in micro plan but NO outreach/mobile services permitted to be conducted / Banned	Inaccessible
6	SOUTH	AFG/08/21/018	HILMAND	NAWZAD	06-01-21	BAGHAK (NAW ZAD)	20	15-01-21	ADEQ	NVI	Area in micro plan but NO outreach/mobile services permitted to be conducted / Banned	Inaccessible
7	WEST	AFG/03/21/008	FARAH	BALABULUK	10-01-21	DIZAK (BALA BULUK)	18	12-01-21	ADEQ	SL2EV	Area in micro plan but NO outreach/mobile services permitted to be conducted / Banned	Inaccessible
8	WEST	AFG/03/21/066	BADGHIS	JAWAND	01-02-21	SHAHRE NAW (JAWAND)	11	11-02-21	ADEQ	NVI	Area in micro plan but NO outreach/mobile services permitted to be conducted / Banned	Inaccessible
9	SOUTH	AFG/08/21/062	ZABUL	MIZAN	31-01-21	MUSHKHANA	9	09-02-21	ADEQ	NVI	Area in micro plan but NO outreach/mobile services conducted / Management issues	Inaccessible
10	SOUTH	AFG/08/21/059	HILMAND	MUSAQALAH	24-01-21	MUSA QALE'H(1)	11	06-02-21	ADEQ	NVI	Area in micro plan but NO outreach/mobile services conducted / Management issues	Inaccessible
11	WEST	AFG/03/21/030	FARAH	BALABULUK	16-01-21	QAL'EH-YE NASRULLAH	7	22-01-21	ADEQ	NVI	Area in micro plan but NO outreach/mobile services permitted to be conducted / Banned	Inaccessible
12	WEST	AFG/03/21/019	BADGHIS	QADIS	12-01-21	LUKA-I-SURKH	10	18-01-21	ADEQ	SL1SL3	Area in micro plan but NO outreach/mobile services permitted to be conducted / Banned	Inaccessible
13	SOUTH	AFG/08/21/016	ZABUL	ARGHANDAB	07-01-21	BARGHANTU	9	13-01-21	ADEQ	cVDPV2	Area in micro plan but NO outreach/mobile services conducted / Management issues	Inaccessible
14	WEST	AFG/03/21/018	BADGHIS	QADIS	07-01-21	DARBANDE SAFED (QADIS)	10	17-01-21	ADEQ	SL1SL3	Area in micro plan but NO outreach/mobile services permitted to be conducted / Banned	Inaccessible
15	SOUTHEAST	AFG/07/21/010	GHAZNI	ANDAR	08-01-21	ABDUL WAL	9	11-01-21	ADEQ	cVDPV2	Area in micro plan but NO outreach/mobile services permitted to be conducted / Banned	Inaccessible
16	WEST	AFG/03/21/006	FARAH	BALABULUK	02-01-21	DAWALATABAD	7	09-01-21	ADEQ	cVDPV2	Area in micro plan but NO outreach/mobile services permitted to be conducted / Banned	Inaccessible
17	SOUTH	AFG/08/21/046	HILMAND	BAGHRAN	05-01-21	BAGHRAN	26	31-01-21	INADEQ	cVDPV2	Area in micro plan but NO outreach/mobile services conducted / Management issues	Quality issues due to AGE interference
18	SOUTH	AFG/08/21/036	KANDAHAR	MAYWAND	09-01-21	MAYWAND	31	28-01-21	INADEQ	SL1	Area in micro plan but NO outreach/mobile services permitted to be conducted / Banned	Inaccessible
19	SOUTH	AFG/08/21/028	HILMAND	MUSAQALAH	01-01-21	SAMAND CHAY	36	17-01-21	INADEQ	NVI	Area in micro plan but NO outreach/mobile services permitted to be conducted / Banned	Quality issues due to AGE interference
20	SOUTH	AFG/08/21/026	HILMAND	BAGHRAN	02-01-21	BAGHRAN	36	15-01-21	ADEQ	NVI	Area in micro plan but NO outreach/mobile services permitted to be conducted / Banned	Quality issues due to AGE interference
21	SOUTH	AFG/08/21/087	ZABUL	MIZAN	14-02-21	MYANJOY KALAY	12	20-02-21	ADEQ	NVI	Lack of community mobilization / tracking / referral	Inaccessible

Zero Dose AFP Cases, 0 - 59 Months 2021 (2/8)

No.	Region	EPID	Province	District	Onset	Village	Age	D. Stool Collection	Adeq	Lab. R	Reason	
											RI	SIAs
22	SOUTH	AFG/08/21/080	KANDAHAR	MAYWAND	13-02-21	MAYWAND CHINA	11	21-02-21	ADEQ	NVI	Lack of community mobilization / tracking / referral	Inaccessible
23	SOUTH	AFG/08/21/082	ZABUL	ATGHAR	16-02-21	ATGHAR (ATGHAR)	36	22-02-21	ADEQ	NVI	Area in micro plan but NO outreach/mobile services conducted / Management issues	Quality issues due to AGE interference
24	WEST	AFG/03/21/074	FARAH	BALABULUK	12-02-21	TUDANAKE BALA	27	16-02-21	ADEQ	NVI	Area in micro plan but NO outreach/mobile services permitted to be conducted / Banned	Inaccessible
25	WEST	AFG/03/21/098	HIRAT	SHINDAND	20-02-21	JAK	9	01-03-21	ADEQ	cVDPV2	Area in micro plan but NO outreach/mobile services conducted / Management issues	Inaccessible
26	SOUTH	AFG/08/21/064	HILMAND	MUSAQALAH	08-02-21	SHABAN	25	13-02-21	ADEQ	NVI	Lack of community mobilization / tracking / referral	Quality issues due to AGE interference
27	SOUTH	AFG/08/21/117	HILMAND	NAWZAD	09-02-21	KUSHK	52	09-03-21	INADEQ	EV	Area in micro plan but NO outreach/mobile services permitted to be conducted / Banned	Refusal
28	SOUTH	AFG/08/21/130	HILMAND	NAWZAD	02-03-21	MAMA KAREZ	4	13-03-21	ADEQ	NVI	Lack of community mobilization / tracking / referral	Inaccessible
29	SOUTH	AFG/08/21/132	ZABUL	SHAHJOY	04-03-21	KALAKHEL	36	12-03-21	ADEQ	NVI	Refusal (for OPV in RI)	Refusal
30	SOUTH	AFG/08/21/159	ZABUL	QALAT	12-03-21	BAKORZAI	14	22-03-21	ADEQ	NVI	Area in micro plan but NO outreach/mobile services permitted to be conducted / Banned	Inaccessible
31	SOUTH	AFG/08/21/152	HILMAND	KAJAKI	11-03-21	CHINAGI	14	20-03-21	ADEQ	cVDPV2	Area in micro plan but NO outreach/mobile services permitted to be conducted / Banned	Inaccessible
32	WEST	AFG/03/21/135	BADGHIS	MUQUR	22-02-21	MUQUR (1) (MUQUR)	12	19-03-21	INADEQ	NVI	Area in micro plan but NO outreach/mobile services permitted to be conducted / Banned	Inaccessible
33	NORTH	AFG/02/21/074	FARYAB	QAYSAR	21-03-21	HAZARA QALA (1)	11	24-03-21	ADEQ	EV	Area in micro plan but NO outreach/mobile services permitted to be conducted / Banned	Inaccessible
34	SOUTH	AFG/08/21/168	HILMAND	REG	19-03-21	REG(KHANISHIN)	7	22-03-21	INADEQ	NVI	Lack of community mobilization / tracking / referral	Inaccessible
35	NORTHEAST	AFG/01/21/081	KUNDUZ	DASHT-E-ARCHI	10-03-21	ARCHI	48	18-03-21	ADEQ	NVI	Insecurity; no/limitation for outreach/mobile services	Inaccessible
36	SOUTH	AFG/08/21/184	HILMAND	NAHR-E-SARAJ	22-03-21	SUR SHAKH	11	31-03-21	ADEQ	NVI	Lack of community mobilization / tracking / referral	Inaccessible
37	WEST	AFG/03/21/161	BADGHIS	JAWAND	25-02-21	DARWAZA (JAWAND)	36	28-03-21	INADEQ	SL3	Area in micro plan but NO outreach/mobile services conducted / Management issues	Inaccessible
38	WEST	AFG/03/21/166	BADGHIS	BALAMURGHAB	18-03-21	CHILUNAK	36	30-03-21	ADEQ	NVI	Area in micro plan but NO outreach/mobile services conducted / Management issues	Inaccessible
39	SOUTH	AFG/08/21/176	HILMAND	REG	19-03-21	REG(KHANISHIN)	48	26-03-21	ADEQ	EV	Lack of community mobilization / tracking / referral	Quality issues due to AGE interference
40	NORTH	AFG/02/21/084	FARYAB	GHORMACH	24-03-21	JAR-I-SYAH (1)	12	01-04-21	ADEQ	EV	Area in micro plan but NO outreach/mobile services conducted / Management issues	Inaccessible
41	SOUTH	AFG/08/21/191	HILMAND	NAHR-E-SARAJ	30-03-21	TAJDARE WALI	25	08-04-21	ADEQ	NVI	Area in micro plan but NO outreach/mobile services permitted to be conducted / Banned	Inaccessible

Zero Dose AFP Cases, 0 - 59 Months 2021 (3/8)

No.	Region	EPID	Province	District	Onset	Village	Age	D. Stool Collection	Adeq	Lab. R	Reason	
											RI	SIAs
42	WEST	AFG/03/21/174	BADGHIS	JAWAND	18-03-21	-	25	31-03-21	ADEQ	NVI	Area in micro plan but NO outreach/mobile services conducted / Management issues	Inaccessible
43	SOUTH	AFG/08/21/192	HILMAND	NAWZAD	25-03-21	ALI ZA'1	30	01-04-21	ADEQ	NVI	Lack of community mobilization / tracking / referral	Quality issues due to AGE interference
44	SOUTH	AFG/08/21/222	ZABUL	MIZAN	04-04-21	PAY DRUSHAK	12	10-04-21	ADEQ	EV	Area in micro plan but NO outreach/mobile services permitted to be conducted / Banned	Inaccessible
45	SOUTH	AFG/08/21/231	HILMAND	NAD-E-ALI	12-04-21	NAD ALI (S)	15	18-04-21	ADEQ	SL1 SL3	Lack of community mobilization / tracking / referral	Inaccessible
46	EAST	AFG/06/21/141	KUNAR	CHAWKAY	18-04-21	AMREY	9	21-04-21	ADEQ	NVI	Area in micro plan but NO outreach/mobile services permitted to be conducted / Banned	Inaccessible
47	SOUTH	AFG/08/21/250	KANDAHAR	ARGHESTAN	20-03-21	TARAKI KALAY	24	21-04-21	INADEQ	NVI	Routine EPI services not available / White areas	Quality issues due to AGE interference
48	WEST	AFG/03/21/200	GHOR	SHAHRAK	09-04-21	JAM	24	14-04-21	ADEQ	NVI	Routine EPI services not available / White areas	Inaccessible
49	SOUTH	AFG/08/21/267	ZABUL	DAYCHOPAN	04-04-21	SAYEDAN (DAYCHOPAN)	12	28-04-21	INADEQ	NVI	Area in micro plan but NO outreach/mobile services permitted to be conducted / Banned	Inaccessible
50	SOUTH	AFG/08/21/241	ZABUL	MIYANASHIN	13-04-21	-	12	22-04-21	ADEQ	NVI	Area in micro plan but NO outreach/mobile services permitted to be conducted / Banned	Inaccessible
51	SOUTH	AFG/08/21/242	ZABUL	QALAT	14-04-21	SHADO	7	22-04-21	ADEQ	NVI	Refusal (for OPV in RI)	Refusal
52	SOUTHEAST	AFG/07/21/130	GHAZNI	QARABAGH	23-04-21	NAWROZKHEL (QARABAGH)	48	27-04-21	ADEQ	SL1SL3	Refusal (for OPV in RI)	Inaccessible
53	SOUTH	AFG/08/21/246	ZABUL	QALAT	15-04-21	TORA (QALAT)	24	22-04-21	ADEQ	NVI	Area in micro plan but NO outreach/mobile services permitted to be conducted / Banned	Quality issues due to AGE interference
54	SOUTH	AFG/08/21/287	ZABUL	QALAT	30-04-21	SHADO	18	05-05-21	ADEQ	NVI	Refusal (for OPV in RI)	Refusal
55	SOUTH	AFG/08/21/283	ZABUL	MIZAN	28-04-21	KHWAJA GUK	12	04-05-21	ADEQ	NVI	Lack of community mobilization / tracking / referral	Inaccessible
56	WEST	AFG/03/21/242	FARAH	BAKWA	26-04-21	SAGHAY	13	02-05-21	ADEQ	NVI	Area in micro plan but NO outreach/mobile services permitted to be conducted / Banned	Inaccessible
57	SOUTH	AFG/08/21/280	ZABUL	NAWBAHAR	15-03-21	NILAY (NAW BAHAR)	14	03-05-21	INADEQ	SL3	Area in micro plan but NO outreach/mobile services permitted to be conducted / Banned	Inaccessible
58	NORTH	AFG/02/21/105	FARYAB	DAWLATABAD	15-04-21	CHAR SHANGHOW (1)	12	26-04-21	ADEQ	SL2	Area in micro plan but NO outreach/mobile services permitted to be conducted / Banned	Inaccessible
59	SOUTH	AFG/08/21/276	ZABUL	TARNAK WA JALDAK	22-04-21	SHAMALI SPEDAKAY	8	03-05-21	ADEQ	EV	Refusal (for OPV in RI)	Inaccessible
60	SOUTH	AFG/08/21/273	HILMAND	NAWZAD	21-04-21	NAW ZAD	30	27-04-21	ADEQ	NVI	Area in micro plan but NO outreach/mobile services permitted to be conducted / Banned	Quality issues due to AGE interference
61	WEST	AFG/03/21/254	BADGHIS	BALAMURGHAB	05-05-21	SINI (1) (BALA MURGHAB)	10	09-05-21	ADEQ	NVI	-	Inaccessible
62	SOUTH	AFG/08/21/288	KANDAHAR	SPINBOLDAK	01-05-21	SPIN BOLDAK	17	06-05-21	ADEQ	SL1	Refusal (for OPV in RI)	Refusal
63	SOUTH	AFG/08/21/298	ZABUL	QALAT	04-05-21	SHENGHALI KALAY	12	09-05-21	ADEQ	NVI	Area in micro plan but NO outreach/mobile services permitted to be conducted / Banned	Inaccessible
64	SOUTH	AFG/08/21/299	HILMAND	MUSAQALAH	01-05-21	KAREZ GHOLAM	15	08-05-21	ADEQ	SL1	Area in micro plan but NO outreach/mobile services permitted to be conducted / Banned	Inaccessible
65	WEST	AFG/03/21/250	FARAH	BALABULUK	30-04-21	TUDANAKE BALA	27	07-05-21	ADEQ	NVI	Area in micro plan but NO outreach/mobile services permitted to be conducted / Banned	Inaccessible
66	South	AFG/08/21/320	ZABUL	DAYCHOPAN	16/05/2021	SHEKHJAY	36	22/05/2021	ADEQ	NVI	Area in micro plan but NO outreach/mobile services permitted to be conducted / Banned	Quality issues due to AGE interference

Zero Dose AFP Cases, 0 - 59 Months 2021 (4/8)

No.	Region	EPID	Province	District	Onset	Village	Age	D. Stool Collection	Adeq	Lab. R	Reason	
											RI	SIAAs
67	SOUTH	AFG/08/21/314	HILMAND	NAWZAD	06/05/2021	NAW ZAD	18	18/05/2021	ADEQ	EV	Area in micro plan but NO outreach/mobile services permitted to be conducted / Banned	Inaccessible
68	SOUTH	AFG/08/21/306	HILMAND	MUSAQALAH	03/05/2021	KAREZE NADAMAT	48	10/05/2021	ADEQ	NVI	Refusal (for OPV in RI)	Refusal
69	SOUTH	AFG/08/21/305	ZABUL	TARNAK WA JALDAK	06/05/2021	RAMAZI KALAY	36	11/05/2021	ADEQ	NVI	Refusal (for OPV in RI)	Refusal
70	NORTH	AFG/02/21/140	FARYAB	QAYSAR	16/05/2021	GHUNDA SANG	24	26/05/2021	ADEQ	EV	Area in micro plan but NO outreach/mobile services permitted to be conducted / Banned	Inaccessible
71	BADAKHSHAN	AFG/12/21/024	BADAKHSHAN	RAGHESTAN	16/05/2021	SEPAH	36	22/05/2021	ADEQ	NVI	Routine EPI services not available / White areas	Inaccessible
72	SOUTH	AFG/08/21/323	ZABUL	MIZAN	17/05/2021	RABAJOY	36	23/05/2021	ADEQ	NVI	Refusal (for OPV in RI)	Refusal
73	WEST	AFG/03/21/217	FARAH	PUSHTROD	16/04/2021	AB SURAKH	14	19/04/2021	ADEQ	cVDPV2	Area in micro plan but NO outreach/mobile services permitted to be conducted / Banned	Inaccessible
74	SOUTH	AFG/08/21/336	ZABUL	DAYCHOPAN	03/05/2021	CHAGHMAT	36	29/05/2021	INADEQ	NVI	Refusal (for OPV in RI)	Inaccessible
75	SOUTH	AFG/08/21/335	HILMAND	NAWZAD	19/05/2021	MAMA KAREZ	24	27/05/2021	ADEQ	EV	Lack of community mobilization / tracking / referral	Inaccessible
76	SOUTHEAST	AFG/07/21/163	PAKTIKA	MATAKHAN	24/05/2021	MOLAYAN (MATA KHAN)	2	31/05/2021	ADEQ	EV	Refusal (for OPV in RI)	Inaccessible
77	CENTRAL	AFG/05/21/361	KABUL	BAGRAMI	23/05/2021	SAHAK	25	27/05/2021	ADEQ	SL1	-	Child lived abroad
78	SOUTHEAST	AFG/07/21/178	GHAZNI	GIRO	02/06/2021	MOHEBBULLAH	24	08/06/2021	ADEQ	NVI	Lack of community mobilization / tracking / referral	Inaccessible
79	SOUTH	AFG/08/21/349	ZABUL	MIZAN	09/06/2021	SAR KALAY (MIZAN)	7	09/06/2021	INADEQ	NVI	Lack of community mobilization / tracking / referral	Inaccessible
80	WEST	AFG/03/21/303	FARAH	BALABULUK	17/05/2021	SUJI JANUBI	30	07/06/2021	INADEQ	EV	Area in micro plan but NO outreach/mobile services permitted to be conducted / Banned	Inaccessible
81	WEST	AFG/03/21/300	FARAH	KHAK-E-SAFED	01/06/2021	KAREZI SADIQ	14	05/06/2021	ADEQ	NVI	Area in micro plan but NO outreach/mobile services permitted to be conducted / Banned	Inaccessible
82	WEST	AFG/03/21/336	FARAH	KHAK-E-SAFED	18/06/2021	DIWARE SURKH	18	21/06/2021	ADEQ	NVI	Area in micro plan but NO outreach/mobile services permitted to be conducted / Banned	Inaccessible
83	NORTH	AFG/02/21/162	FARYAB	QAYSAR	22/04/2021	TAMUCHI (1)	19	18/06/2021	INADEQ	NVI	Area in micro plan but NO outreach/mobile services permitted to be conducted / Banned	Inaccessible
84	WEST	AFG/03/21/333	FARAH	BALABULUK	12/06/2021	SIAH JANGAL	24	19/06/2021	ADEQ	NVI	Area in micro plan but NO outreach/mobile services permitted to be conducted / Banned	Inaccessible
85	SOUTH	AFG/08/21/369	ZABUL	QALAT	08/06/2021	BAKORZAI	18	16/06/2021	ADEQ	NVI	Area in micro plan but NO outreach/mobile services permitted to be conducted / Banned	Inaccessible
86	SOUTH	AFG/08/21/367	URUZGAN	DEHRAWUD	09/06/2021	JOYE NAW (DIHRAWUD)	3	16/06/2021	ADEQ	SL1	Area in micro plan but NO outreach/mobile services permitted to be conducted / Banned	Inaccessible
87	SOUTH	AFG/08/21/360	HILMAND	KAJAKI	07/06/2021	KAREZE NAW (KAJAKI)	10	14/06/2021	ADEQ	SL3+SL1	Area in micro plan but NO outreach/mobile services permitted to be conducted / Banned	Inaccessible
88	SOUTH	AFG/08/21/358	URUZGAN	DEHRAWUD	05/06/2021	LUNDYANA	12	13/06/2021	ADEQ	NVI	Lack of community mobilization / tracking / referral	Inaccessible
89	SOUTH	AFG/08/21/410	HILMAND	GARMSER	06-06-21	LAKRAI	18	03/07/2021	INADEQ	SL1	Area in micro plan but NO outreach/mobile services permitted to be conducted / Banned	Inaccessible
90	WEST	AFG/03/21/356	FARAH	FARAH	23-06-21	GARM AB	16	29-06-21	ADEQ	NVI	Area in micro plan but NO outreach/mobile services permitted to be conducted / Banned	Inaccessible

Zero Dose AFP Cases, 0 - 59 Months 2021 (5/8)

No.	Region	EPID	Province	District	Onset	Village	Age	D. Stool Collection	Adeq	Lab. R	Reason	
											RI	SIAs
91	SOUTH	AFG/08/21/401	ZABUL	MIZAN	21-06-21	BADAMAK KALAY	18	27-06-21	ADEQ	NVI	Area in micro plan but NO outreach/mobile services permitted to be conducted / Banned	Inaccessible
92	SOUTH	AFG/08/21/397	HILMAND	NAWZAD	20-06-21	GARMA SHAMALI	15	26-06-21	ADEQ	NPEV	Area in micro plan but NO outreach/mobile services permitted to be conducted / Banned	Inaccessible
93	SOUTH	AFG/08/21/430	ZABUL	QALAT	05-07-21	KHALEQDADKHAN	18	14/07/2021	ADEQ	NPEV	Area in micro plan but NO outreach/mobile services permitted to be conducted / Banned	Inaccessible
94	SOUTH	AFG/08/21/429	HILMAND	WASHER	08-07-21	URGOLI	30	13/07/2021	ADEQ	NVI	Area in micro plan but NO outreach/mobile services permitted to be conducted / Banned	Inaccessible
95	SOUTH	AFG/08/21/428	ZABUL	MIZAN	07-07-21	TUGARAK	18	11/07/2021	ADEQ	SL1	Lack of community mobilization / tracking / referral	Inaccessible
96	SOUTH	AFG/08/21/427	HILMAND	MUSAQALAH	04-07-21	SHARAGA	12	09/07/2021	ADEQ	NVI	Lack of community mobilization / tracking / referral	Inaccessible
97	CENTRAL	AFG/05/21/461	WARDAK	JALREZ	04-07-21	ZAYWALAYAT	18	10/07/2021	ADEQ	NVI	Area in micro plan but NO outreach/mobile services conducted / Management issues	Inaccessible
98	SOUTH	AFG/08/21/421	HILMAND	NAD-E-ALI	26-05-21	SISTANY	3	08/07/2021	INADEQ	NVI	Area in micro plan but NO outreach/mobile services permitted to be conducted / Banned	Inaccessible
99	SOUTH	AFG/08/21/400	ZABUL	SHAHJOY	22-06-21	LUDINE SHARQI	28	-	INADEQ	NPEV	Lack of community mobilization / tracking / referral	Quality issues due to AGE interference
100	NORTH	AFG/02/21/159	BALKH	MAZAR-E-SHARIF	10-06-21	MAZARI SHARIF	24	15/06/2021	ADEQ	NPEV	Refusal (for OPV in RI)	Refusal
101	SOUTH	AFG/08/21/437	HILMAND	NAWZAD	11-07-21	KHAWI	18	17-07-21	ADEQ	NVI	Lack of community mobilization / tracking / referral	Inaccessible
102	SOUTH	AFG/08/21/436	KANDAHAR	SHAHWALIKOT	11-07-21	CHIGHAK	6	18-07-21	ADEQ	NVI	Area in micro plan but NO outreach/mobile services permitted to be conducted / Banned	Inaccessible
103	SOUTH	AFG/08/21/435	HILMAND	NAHR-E-SARAJ	02-07-21	SUR SHAKH	17	16-07-21	ADEQ	SL1+SL3	Refusal (for OPV in RI)	Refusal
104	CENTRAL	AFG/05/21/521	WARDAK	SAYDABAD	29-07-21	MALIKHEL(BARATKHEL)	29	01-08-21	ADEQ	NVI	Refusal (for OPV in RI)	Inaccessible
105	SOUTH	AFG/08/21/461	HILMAND	BAGHRAN	05/07/2021	ANQAR CHAQ	36	05/08/2021	INADEQ	EV	Area in micro plan but NO outreach/mobile services permitted to be conducted / Banned	Compromised quality due to interference
106	NORTH	AFG/02/21/214	JAWZJAN	MARDYAN	09/08/2021	CHELIK-E AYAS KHAN	18	15/08/2021	15/08/2021	NVI	Lack of community mobilization / tracking / referral	Inaccessible
107	SOUTH	AFG/08/21/485	ZABUL	KAKAR	07/08/2021	TURGAN	13	17/08/2021	17/08/2021	NVI	Lack of community mobilization / tracking / referral	Inaccessible
108	WEST	AFG/03/21/424	HERAT	ADRASKAN	01/07/2021	MIR ABAD	7	19/08/2021	19/08/2021	EV	Area in micro plan but NO outreach/mobile services permitted to be conducted / Banned	Inaccessible
109	SOUTH	AFG/08/21/491	NIMROZ	KHASHROD	09/08/2021	DILARAM	14	17/08/2021	17/08/2021	NVI	Lack of community mobilization / tracking / referral	Inaccessible
110	WEST	AFG/03/21/421	BADGHIS	QADIS	04/08/2021	KHAYRKHANA (QADIS)	29	16/08/2021	16/08/2021	NVI	Area in micro plan but NO outreach/mobile services permitted to be conducted / Banned	Inaccessible
111	SOUTH	AFG/08/21/475	KANDAHAR	SHAH WALI KOT	03/08/2021	SHAH WALI KOT	17	13/08/2021	13/08/2021	SL1+SL3	Area in micro plan but NO outreach/mobile services permitted to be conducted / Banned	Inaccessible
112	SOUTH	AFG/08/21/505	HILMAND	MUSAQALAH	15/08/2021	SARBESHA	4	24/08/2021	ADEQ	SL1+SL3	Area in micro plan but NO outreach/mobile services permitted to be conducted / Banned	Inaccessible
113	CENTRAL	AFG/05/21/565	LOGAR	PUL-E- ALAM	20/08/2021	KHATO KALAY(DABAZA'I)	25	22/08/2021	ADEQ	NVI	-	Inaccessible
114	SOUTH	AFG/08/21/497	HILMAND	MUSAQALAH	04/08/2021	REGAY (1)	24	21/08/2021	INADEQ	NVI	Area in micro plan but NO outreach/mobile services permitted to be conducted / Banned	Inaccessible

Zero Dose AFP Cases, 0 - 59 Months 2021 (6/8)

No.	Region	EPID	Province	District	Onset	Village	Age	D. Stool Collection	Adeq	Lab. R	Reason	
											RI	SIAs
115	SOUTH	AFG/08/21/529	ZABUL	ARGHANDAB	24/08/2021	BALANDWARKH	28	04/09/2021	ADEQ	NVI	Area in micro plan but NO outreach/mobile services permitted to be conducted / Banned	Compromised quality due to interference
116	NORTH	AFG/02/21/230	SAR-E-PUL	KOHESTANAT	26/08/2021	SALREZ	48	31/08/2021	ADEQ	NVI	Area in micro plan but NO outreach/mobile services permitted to be conducted / Banned	Compromised quality due to interference
117	SOUTH	AFG/08/21/519	HILMAND	NAD-E-ALI	27/08/2021	MARJA	30	03/09/2021	ADEQ	NVI	Lack of community mobilization / tracking / referral	Inaccessible
118	SOUTH	AFG/08/21/507	HILMAND	NAWZAD	14/08/2021	ALI ABAD	8	27/08/2021	ADEQ	NVI	Area in micro plan but NO outreach/mobile services permitted to be conducted / Banned	Inaccessible
119	CENTRAL	AFG/05/21/605	WARDAK	NERKH	09/09/2021	PADSHAKHEL	24	15/09/2021	ADEQ	SL1+SL3	Area in micro plan but NO outreach/mobile services permitted to be conducted / Banned	Inaccessible
120	SOUTH	AFG/08/21/537	KANDAHAR	SHAHWALIKOT	07/09/2021	KUNDELAN	7	11/09/2021	ADEQ	NVI	Area in micro plan but NO outreach/mobile services permitted to be conducted / Banned	Inaccessible
121	SOUTHEAST	AFG/07/21/269	KHOST	SPERA	20/09/2021	PACA MELA	12	24/09/2021	ADEQ	NPEV	Routine EPI services not available / White areas	Inaccessible
122	SOUTH	AFG/08/21/553	ZABUL	DAYCHOPAN	10/09/2021	KOTANA	15	17/09/2021	ADEQ	NVI	Area in micro plan but NO outreach/mobile services conducted / Management issues	Inaccessible
123	SOUTH	AFG/08/21/549	HILMAND	WASHER	28/08/2021	SHAH MIRZA KAREZ	3	15/09/2021	INADEQ	NVI	Area in micro plan but NO outreach/mobile services permitted to be conducted / Banned	Inaccessible
124	SOUTH	AFG/08/21/548	HILMAND	NAD-E-ALI	02/09/2021	MARJA	36	15/09/2021	ADEQ	NVI	Lack of community mobilization / tracking / referral	Inaccessible
125	SOUTH	AFG/08/21/565	HILMAND	MUSAQALAH	31-08-21	LANDAY	12	20-02-21	INADEQ	NVI	Area in micro plan but NO outreach/mobile services permitted to be conducted / Banned	Inaccessible
126	WEST	AFG/03/21/492	FARAH	BALABULUK	27/09/2021	DIZAK (BALA BULUK)	18	03/10/2021	ADEQ	NVI	Area in micro plan but NO outreach/mobile services permitted to be conducted / Banned	Inaccessible
127	WEST	AFG/03/21/490	GHOR	TAYWARAH	23/09/2021	GALABED (TAYWARA)	30	30/09/2021	ADEQ	NPEV	Area in micro plan but NO outreach/mobile services permitted to be conducted / Banned	Inaccessible
128	SOUTH	AFG/08/21/580	HILMAND	NAD-E-ALI	24/09/2021	NAD ALI	16	30/09/2021	ADEQ	NVI	Area in micro plan but NO outreach/mobile services permitted to be conducted / Banned	Inaccessible
129	SOUTH	AFG/08/21/578	HILMAND	NAHR-E-SARAJ	17/09/2021	SHORAKYAN	20	30/09/2021	ADEQ	NVI	Lack of community mobilization / tracking / referral	Inaccessible
130	SOUTHEAST	AFG/07/21/272	GHAZNI	QARABAGH	20/09/2021	HAMZAKHEL	11	27/09/2021	ADEQ	NPEV	Area in micro plan but NO outreach/mobile services permitted to be conducted / Banned	Inaccessible
131	SOUTH	AFG/08/21/563	HILMAND	NAD-E-ALI	20/09/2021	MARJA	33	23/09/2021	ADEQ	SL1+SL3+ NPEV	Lack of community mobilization / tracking / referral	Inaccessible
132	SOUTH	AFG/08/21/576	HILMAND	NAWZAD	27/09/2021	DU RODI	30	03/10/2021	ADEQ	NPEV	Area in micro plan but NO outreach/mobile services permitted to be conducted / Banned	Inaccessible
133	SOUTHEAST	AFG/07/21/301	GHAZNI	ANDAR	10/10/2021	ATUL	10	21/10/2021	ADEQ	NVI	Area in micro plan but NO outreach/mobile services permitted to be conducted / Banned	Inaccessible
134	SOUTH	AFG/08/21/620	ZABUL	MIZAN	12/10/2021	TOR KAC	18	17/10/2021	ADEQ	NVI	Area in micro plan but NO outreach/mobile services permitted to be conducted / Banned	Inaccessible
135	SOUTH	AFG/08/21/615	KANDAHAR	KANDAHAR	15/10/2021	SHAHRE NAW	12	18/10/2021	ADEQ	NVI	Area in micro plan but NO outreach/mobile services permitted to be conducted / Banned	Inaccessible
136	SOUTH	AFG/08/21/613	HILMAND	NAWZAD	07/10/2021	KUSHK	48	18/10/2021	ADEQ	NVI	Area in micro plan but NO outreach/mobile services permitted to be conducted / Banned	Compromised quality due to interference
137	NORTHEAST	AFG/01/21/317	TAKHAR	NAMAKAB	12/10/2021	DEH-I-MURSALAN	7	25/10/2021	ADEQ	NPEV	Area in micro plan but NO outreach/mobile services permitted to be conducted / Banned	Inaccessible
138	WEST	AFG/03/21/525	FARAH	GULESTAN	20/10/2021	KOTALAK (GULISTAN)	3	26/10/2021	ADEQ	NVI	Area in micro plan but NO outreach/mobile services permitted to be conducted / Banned	Inaccessible

Zero Dose AFP Cases, 0 - 59 Months 2021 (7/8)

No.	Region	EPID	Province	District	Onset	Village	Age	D. Stool Collection	Adeq	Lab. R	Reason	
											RI	SIAs
139	EAST	AFG/06/21/423	NANGARHAR	ACHIN	15/10/2021	DOMGAL	18	25/10/2021	ADEQ	NVI	Routine EPI services not available / White areas	Inaccessible
140	SOUTH	AFG/08/21/641	HILMAND	NAD-E-ALI	15/10/2021	NAD ALI	9	26/10/2021	ADEQ	NVI	Area in micro plan but NO outreach/mobile services permitted to be conducted / Banned	Inaccessible
141	SOUTH	AFG/08/21/665	HILMAND	NAHR-E-SARAJ	31/10/2021	BANO KALAY	18	03/11/2021	ADEQ	NPEV	Area in micro plan but NO outreach/mobile services permitted to be conducted / Banned	Inaccessible
142	SOUTH	AFG/08/21/657	KANDAHAR	KHAKREZ	29/10/2021	ASAD KALAY	36	02/11/2021	ADEQ	NVI	Area in micro plan but NO outreach/mobile services permitted to be conducted / Banned	Inaccessible
143	SOUTH	AFG/08/21/652	HILMAND	BAGHRAN	21/10/2021	SARE BAGH (2)	10	27/10/2021	ADEQ	NPEV	Area in micro plan but NO outreach/mobile services conducted / Management issues	Inaccessible
144	WEST	AFG/03/21/531	HIRAT	ADRASKAN	06/07/2021	ADRASKAN	15	-	INADEQ	NA	Area in micro plan but NO outreach/mobile services permitted to be conducted / Banned	Inaccessible
145	SOUTHEAST	AFG/07/21/310	PAKTIKA	WAZAKHAH	26/10/2021	SHAKUR KALAY	3	28/10/2021	ADEQ	NVI	Area in micro plan but NO outreach/mobile services permitted to be conducted / Banned	Child immunized as per age and SIA campaigns planned and conducted
146	SOUTH	AFG/08/21/693	HILMAND	NAD-E-ALI	01/11/2021	LUY BAGH	48	11/11/2021	ADEQ	NVI	Lack of community mobilization / tracking / referral	Inaccessible
147	SOUTHEAST	AFG/07/21/323	GHAZNI	GIRO	29/10/2021	BATUR	1	10/11/2021	ADEQ	NVI	Area in micro plan but NO outreach/mobile services permitted to be conducted / Banned	Inaccessible
148	SOUTHEAST	AFG/07/21/320	GHAZNI	GIRO	27/10/2021	AZMAT (GIRO)	11	08/11/2021	ADEQ	NVI	Area in micro plan but NO outreach/mobile services permitted to be conducted / Banned	Inaccessible
149	SOUTH	AFG/08/21/722	ZABUL	QALAT	21/11/2021	ENJERGAY	30	26/11/2021	ADEQ	NVI	Refusal (for OPV in RI)	Refusal
150	CENTRAL	AFG/05/21/738	DAYKUNDI	GIZAB	05/11/2021	YARKOL	12	19/11/2021	ADEQ	NVI	Routine EPI services not available / White areas	Inaccessible
151	SOUTH	AFG/08/21/711	URUZGAN	SHAHID-E-HASSAS	06/11/2021	SHAHIDI HASSAS	18	18/11/2021	ADEQ	SL3+NPEV	Area in micro plan but NO outreach/mobile services permitted to be conducted / Banned	Inaccessible
152	SOUTHEAST	AFG/07/21/334	GHAZNI	NAWA	12/11/2021	EKHTYARKHEL	23	21/11/2021	ADEQ	SL3	Area in micro plan but NO outreach/mobile services permitted to be conducted / Banned	Inaccessible
153	NORTH	AFG/02/21/284	FARYAB	KHWAJASABZPOSH	04/11/2021	LAQMAN (4)	36	15/11/2021	ADEQ	NVI	Area in micro plan but NO outreach/mobile services permitted to be conducted / Banned	Inaccessible
154	NORTHEAST	AFG/01/21/367	KUNDUZ	EMAMSAHEB	27/11/2021	GUMBAZ (IMAM SAHIB)	18	09/12/2021	ADEQ	NVI	Area in micro plan but NO outreach/mobile services permitted to be conducted / Banned	Inaccessible
155	WEST	AFG/03/21/581	FARAH	BALABULUK	28/11/2021	TUDANAKE BALA	22	04/12/2021	ADEQ	NPEV	Area in micro plan but NO outreach/mobile services permitted to be conducted / Banned	Inaccessible
156	SOUTH	AFG/08/21/744	KANDAHAR	KANDAHAR	26/11/2021	EBRAHIM KHALIFA BABA KALAY	5	05/12/2021	ADEQ	NVI	Lack of community mobilization / tracking / referral	Inaccessible
157	SOUTHEAST	AFG/07/21/349	KHOST	NADIRSHAHKOT	26/11/2021	SHEMBAWOT	30	04/12/2021	ADEQ	NVI	Refusal (for OPV in RI)	Refusal
158	SOUTHEAST	AFG/07/21/348	GHAZNI	ANDAR	25/11/2021	PAYENDAY	9	03/12/2021	ADEQ	NVI	Area in micro plan but NO outreach/mobile services permitted to be conducted / Banned	Inaccessible
159	SOUTHEAST	AFG/07/21/343	GHAZNI	GHAZNI	22/11/2021	GHAYB QALANDAR	24	30/11/2021	ADEQ	SL3	Refusal (for OPV in RI)	Refusal

Zero Dose AFP Cases, 0 - 59 Months 2021 (8/8)

No.	Region	EPID	Province	District	Onset	Village	Age	D. Stool Collection	Adeq	Lab. R	Reason	
											RI	SIAs
160	WEST	AFG/03/21/554	GHOR	TAYWARAH	09/11/2021	ESFAWR (2)	7	18/11/2021	ADEQ	SL2+SL3	Area in micro plan but NO outreach/mobile services permitted to be conducted / Banned	Inaccessible
161	SOUTH	AFG/08/21/777	URUZGAN	KHASURUZGAN	10/12/2021	KARCHUGH	12	15/12/2021	ADEQ	NVI	Refusal (for OPV in RI)	Inaccessible
162	SOUTH	AFG/08/21/805	HILMAND	MUSAQALAH	13/12/2021	DEH ZUHRE ULYA	48	23/12/2021	ADEQ	NVI	Area in micro plan but NO outreach/mobile services conducted / Management issues	Compromised quality due to interference
163	SOUTH	AFG/08/21/790	HILMAND	BAGHRAN	15/12/2021	ZARWAN	27	20/12/2021	ADEQ	NVI	Area in micro plan but NO outreach/mobile services conducted / Management issues	Inaccessible
164	SOUTHEAST	AFG/07/21/366	GHAZNI	ZANAKHAN	06/12/2021	QALA-I-SABZ (ZANA KHAN)	24	17/12/2021	ADEQ	SL1	Area in micro plan but NO outreach/mobile services permitted to be conducted / Banned	Inaccessible
165	NORTH	AFG/02/21/324	FARYAB	KOHESTAN	24/12/2021	SYAHTOB	23	29/12/2021	ADEQ	NVI	Area in micro plan but NO outreach/mobile services permitted to be conducted / Banned	Inaccessible
166	SOUTH	AFG/08/21/824	HILMAND	MUSAQALAH	25/12/2021	KAREZE BAHADUR	24	02/01/2022	ADEQ	SL1	Refusal (for OPV in RI)	Refusal
167	SOUTH	AFG/08/21/816	ZABUL	MIZAN	28/12/2021	ARGATU	42	03/01/2022	ADEQ	NVI	Area in micro plan but NO outreach/mobile services conducted / Management issues	Compromised quality due to interference
168	SOUTHEAST	AFG/07/21/383	PAKTIKA	SAROBI	25/12/2021	NAWAY PASANAY	34	30/12/2021	ADEQ	SL2	Refusal (for OPV in RI)	Refusal

Zero Dose AFP Cases, 0 - 59 Months 2022

No.	Region	EPID	Province	District	Onset	Village	Age	D. Stool Collection	Adeq	Lab. R	Reason	
											RI	SIA
1	NORTH	AFG/02/22/004	SAR-E-PUL	SAR-E-PUL	05/01/2022	-	9	10/01/2022	ADEQ	NVI	PEND	PEND
2	NORTH	AFG/02/22/003	FARYAB	ANDKHOY	02/01/2022	-	36	05/01/2022	ADEQ	NVI	PEND	PEND
3	SOUTHEAST	AFG/07/22/010	PAKTIKA	DILA	09/01/2022	-	36	18/01/2022	ADEQ	NVI	Area in micro plan but NO outreach/mobile services permitted to be conducted / Banned	Inaccessible
4	NORTH	AFG/02/22/021	JAWZJAN	SHIBERGHAN	18/01/2022	-	7	26/01/2022	ADEQ	PEND	-	Child adequately immunized as per age and SIA campaigns conducted
5	SOUTHEAST	AFG/07/22/056	PAKTYA	LIJA AHMAD KHEL	10/02/2022	-	18	15/02/2022	ADEQ	PEND	PEND	PEND
6	SOUTHEAST	AFG/07/22/055	PAKTYA	JANIKHEL	09/02/2022	-	57	14/02/2022	ADEQ	PEND	PEND	PEND
7	SOUTHEAST	AFG/07/22/054	KHOST		11/02/2022	-	24	13/02/2022	ADEQ	PEND	PEND	PEND
8	SOUTH	AFG/08/22/086	KANDAHAR	KANDAHAR	10/02/2022	MANZELBAGH	11	14/02/2022	ADEQ	PEND	PEND	PEND
9	NORTH	AFG/02/22/032	JAWZJAN	MINGAJIK	05/02/2022	HARUNI AWAL	24	09/02/2022	ADEQ	PEND	PEND	PEND
10	WEST	AFG/03/22/038	FARAH	BAKWA	21/01/2022	GHAZIABAD (BAKWA)	22	30/01/2022	ADEQ	PEND	PEND	PEND
11	SOUTH	AFG/08/22/077	HILMAND	KAJAKI	02/02/2022	KAJAKI (KAJAKI)	48	08/02/2022	ADEQ	PEND	PEND	PEND
12	SOUTH	AFG/08/22/056	HILMAND	SANGIN	29/01/2022	REGAY (SANGIN)	14	03/02/2022	ADEQ	PEND	PEND	PEND
13	SOUTHEAST	AFG/07/22/026	PAKTIKA	DILA	14/01/2022	MINZI (DILA)	24	23/01/2022	ADEQ	NSL1	PEND	PEND
14	NORTH	AFG/02/22/013	BALKH	CHARBULAK	07/01/2022	SABZI KAR	13	20/01/2022	ADEQ	NVI	PEND	PEND

Map showing Zero Dose AFP Cases, 0 - 59 Months

2020
N= 192

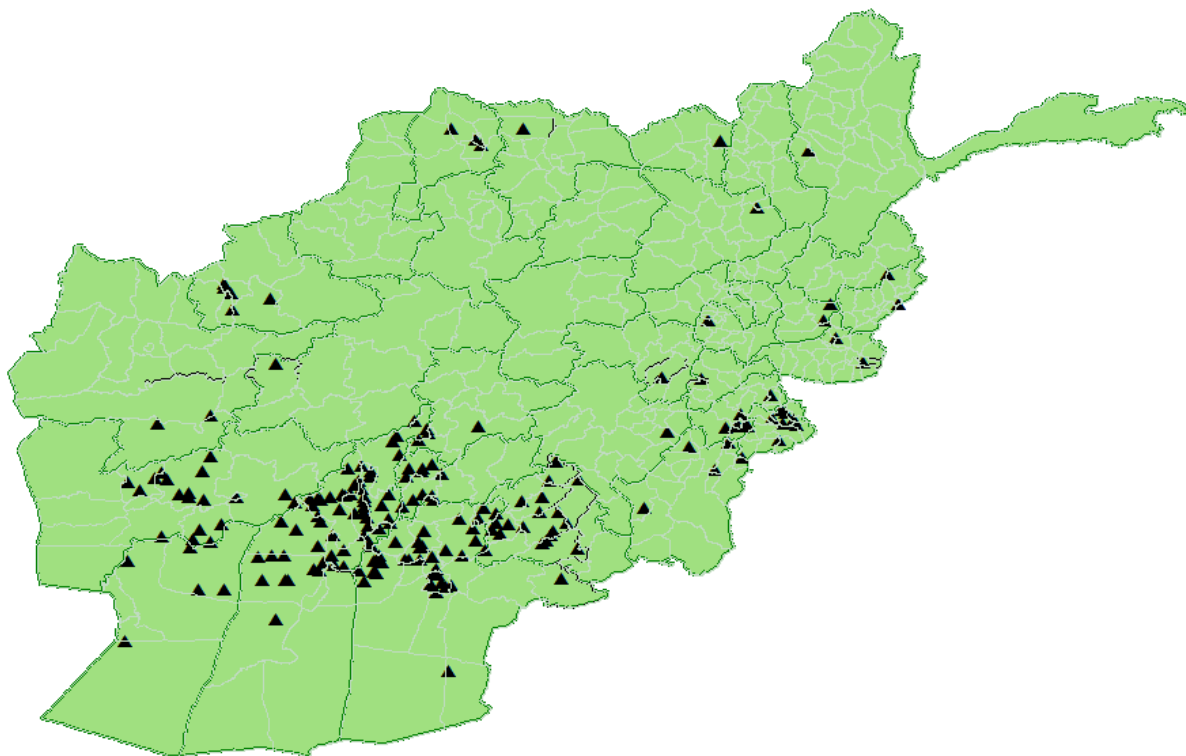

2021
N= 168

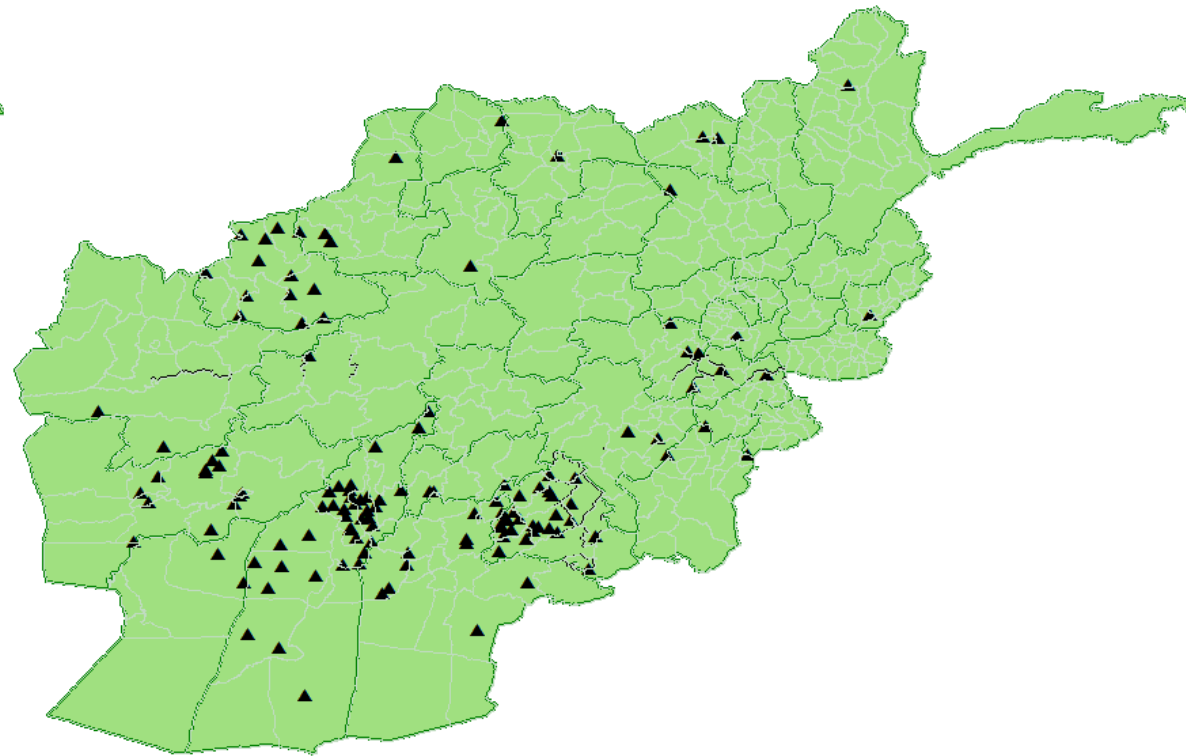

▲ 1 Dot= 1 AFP case

List of AFP Cases with L20B+ Results

Province	District	Epid #	Onset	Age (M)	Sex	RI	SIAs	Dt.Last OPV	Urgent by Field	D. Stool Collection
BAGHLAN	BURKA	AFG/01/21/402-C2	-	18	F	0	-	17-01-22	N	02-02-22

AFP Case Pending for Expert Review Committee (ERC)

EPID	Onset	Province	District	Sex	Age	Doses	D. Stool Collection	Lab. R	60 D-FU Result
AFG/08/21/653	22/10/2021	URUZGAN	SHAHID-E-HASSAS	F	22	4	27/10/2021	SL3	DIED
AFG/08/21/680	18/10/2021	HILMAND	SANGIN	M	96	7	07/11/2021	NVI	RES WEAK
AFG/08/21/685	25/10/2021	HILMAND	NAWZAD	F	19	3	10/11/2021	NVI	RES WEAK
AFG/08/21/770	01/12/2021	HILMAND	KAJAKI	F	65	0	10/12/2021	NVI	DIED
AFG/08/21/653	22/10/2021	URUZGAN	SHAHID-E-HASSAS	F	22	4	27/10/2021	SL3	DIED
AFG/08/21/680	18/10/2021	HILMAND	SANGIN	M	96	7	07/11/2021	NVI	RES WEAK
AFG/08/21/669	15/10/2021	HILMAND	LASHKARGAH	F	110	7+	-	-	DIED
AFG/08/21/685	25/10/2021	HILMAND	NAWZAD	F	19	3	10/11/2021	NVI	RES WEAK
AFG/08/21/726	24/11/2021	KANDAHAR	ZHERAY	F	30	7+	25/11/2021	NVI	DIED
AFG/08/21/770	01/12/2021	HILMAND	KAJAKI	F	65	0	-	NVI	DIED
AFG/03/21/623	10/12/2021	HIRAT	KARUKH	M	156	7+	-	-	DIED
AFG/03/21/630	14/12/2021	HIRAT	INJIL	F	44	7+	10/01/2022	NVI	LOST
AFG/08/21/827	08/12/2021	HILMAND	NAD-E-ALI	F	59	3	14/01/2022	NVI	DIED

Regional Reference Lab Update 2021-2022

Month of onset	Cases	Cases under process		Negative cases	NPEV	NPEV %	Within 14 days	Positive cases			
		Culture	ITD					Wild	Vaccine	aVDPV	cVDPV
Total Month Jan	343	0	0	236	38	11%	100%	1	53	0	15
Total Month Feb	323	0	0	246	36	11%	100%	0	33	1	7
Total Month Mar	361	0	0	261	60	17%	100%	0	30	1	9
Total Month Apr	369	0	0	285	57	15%	99%	0	22	0	5
Total Month May	361	0	0	262	74	20%	100%	0	24	0	1
Total Month Jun	320	0	0	223	70	22%	100%	0	26	0	1
Total Month Jul	288	0	0	184	93	32%	92%	0	10	0	1
Total Month Aug	298	0	0	209	78	26%	100%	0	11	0	0
Total Month Sep	300	0	0	217	57	19%	100%	0	26	0	0
Total Month Oct	396	0	0	308	64	16%	100%	2	22	0	0
Total Month Nov	335	0	0	245	45	13%	100%	1	44	0	0
Total Month Dec	346	1	0	245	56	16%	100%	0	44	0	0
Total AFP cases	4040	1	0	2921	728	18%	99%	4	345	2	39
Contacts	894	6	0	665	148	17%	99%	0	65	0	10
Total cases	4928	10	1	3581	872	18%	99%	4	409	2	49
Jan Week_1	85	3	0	60	13	15%	100%	0	9	0	0
Jan Week_2	66	2	0	48	9	14%	100%	1	6	0	0
Jan Week_3	99	3	0	71	16	17%	100%	0	9	0	0
Jan Week_4	83	40	0	31	8	19%	100%	0	4	0	0
Total Month Jan	333	48	0	210	46	16%	100%	1	28	0	0
Total Month Feb	93	93	0	0	0	0%	0%	0	0	0	0
Total AFP cases	426	141	0	210	46	16%	100%	1	28	0	0
Contacts	51	27	0	18	5	21%	100%	0	1	0	0
Total cases	477	168	0	228	51	16%	100%	1	29	0	0

Vaccination status of Non-Polio AFP cases 6-59 Months- National

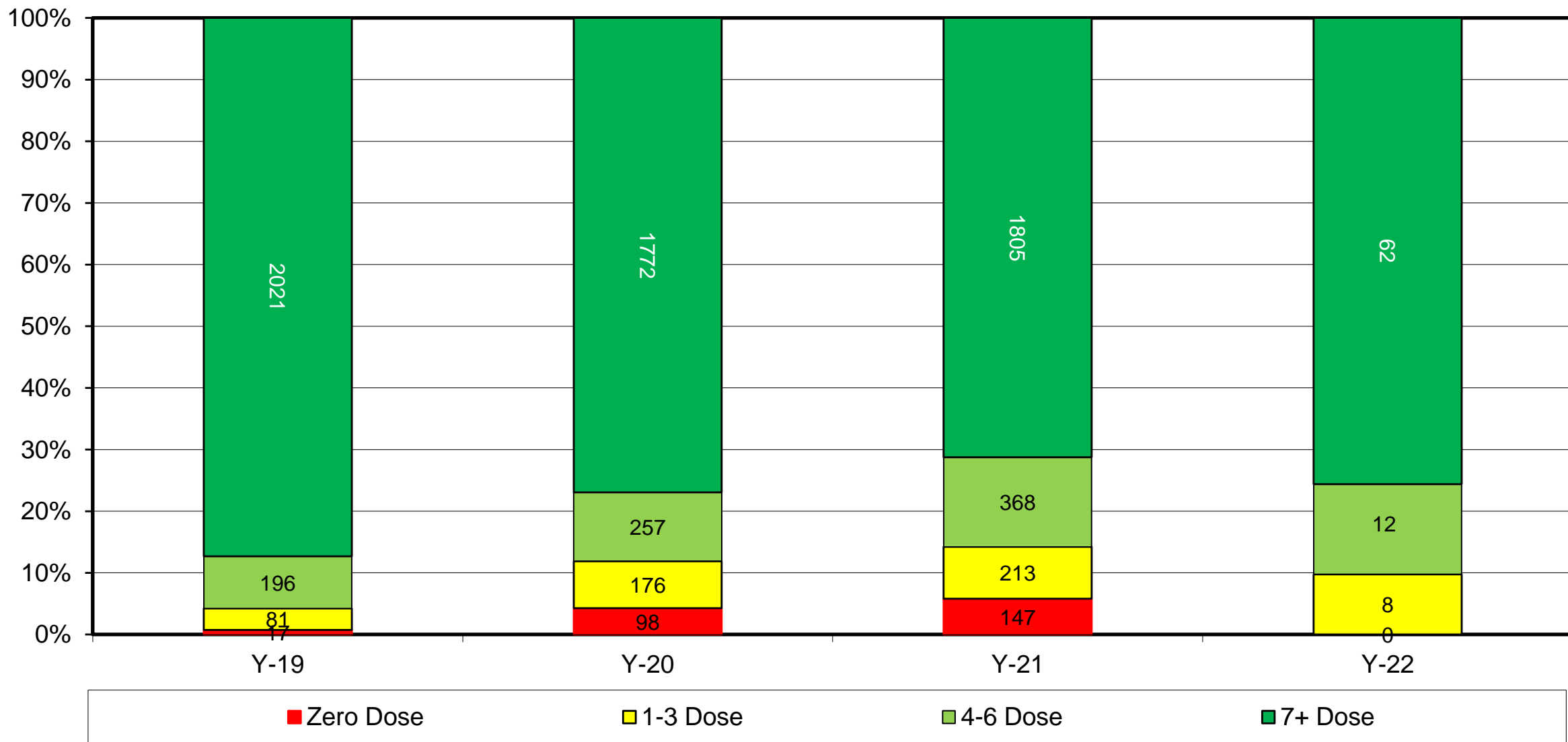

Vaccination status of Non-Polio AFP cases 6-59 Months- Region

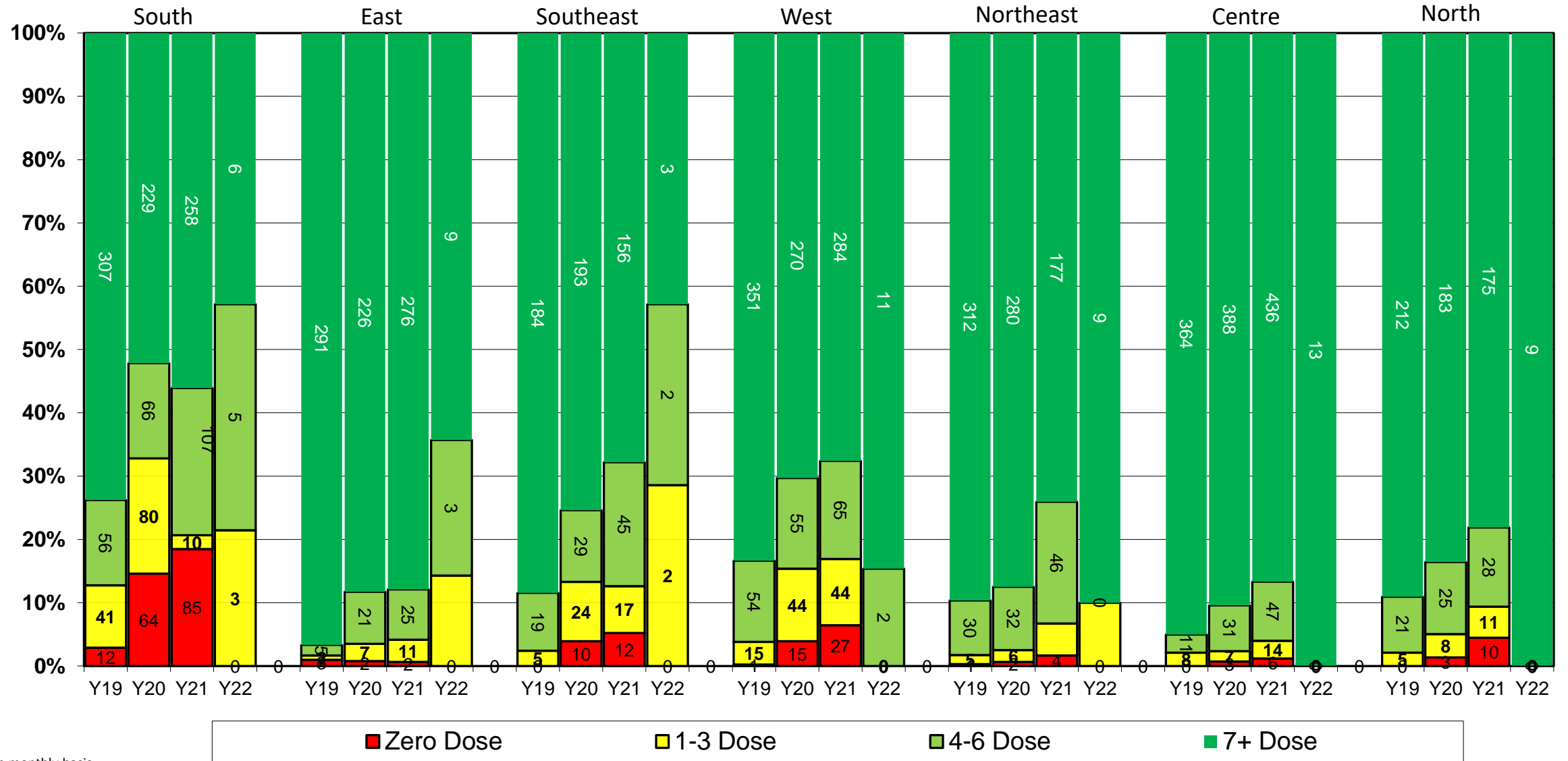

Revised on monthly basis

Data up to 12 Feb 22

Vaccination status of Non-Polio AFP cases 6-59 Months- High Risk Provinces

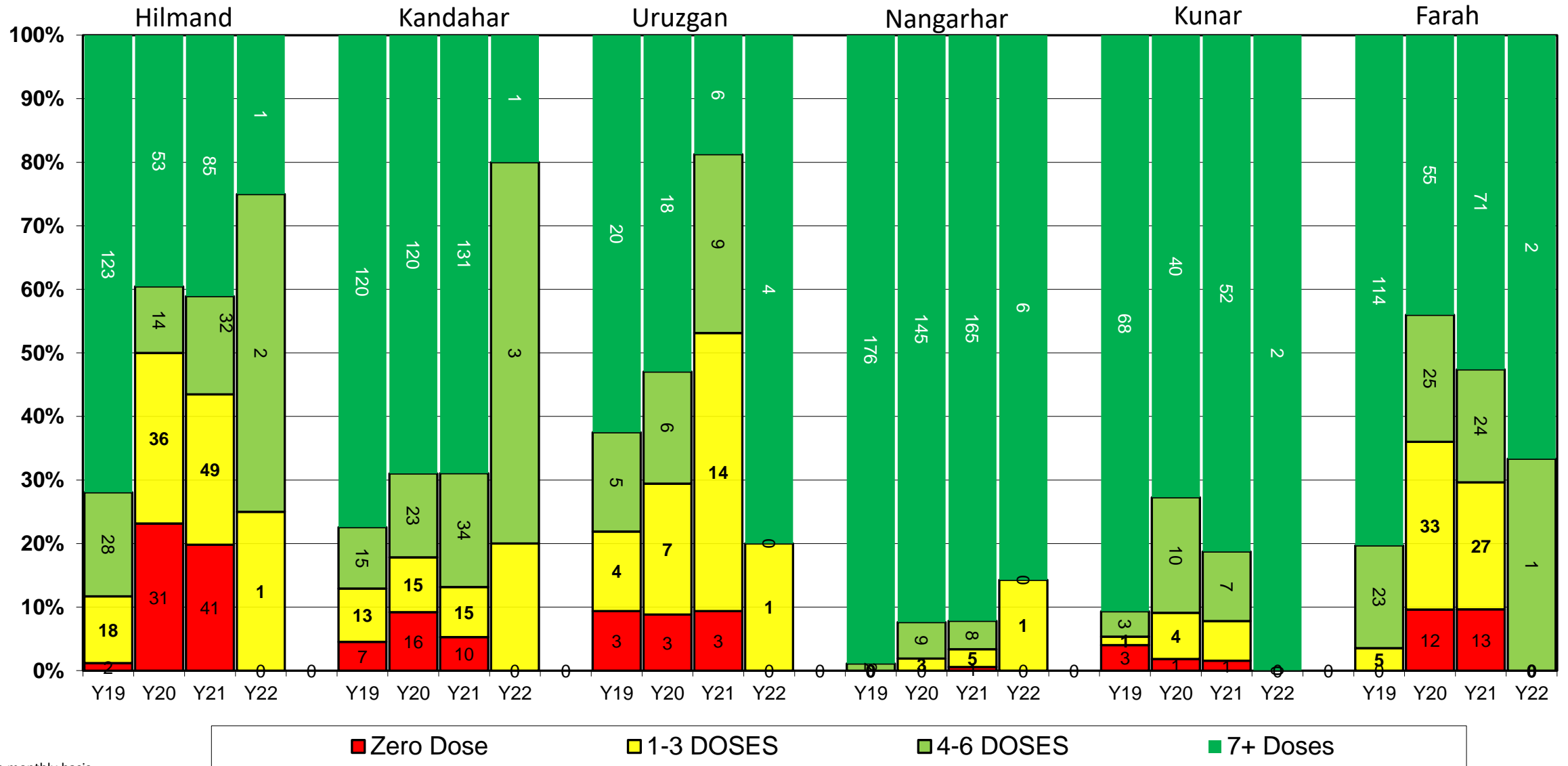

Revised on monthly basis

Data up to 12 Feb 22

Vaccination Status of Non- Polio AFP cases, 6-59 Months (1/2)

REGION	PROVINCE	2019 (% Dose)				2020 (% Dose)				2021 (% Dose)				2022 (% Dose)			
		0	1-3	4-6	7+	0	1-3	4-6	7+	0	1-3	4-6	7+	0	1-3	4-6	7+
South	HILMAND	1.2	10.5	16.4	71.9	23.1	26.9	10.4	39.6	19.8	23.7	15.5	41.1	0.0	25.0	50.0	25.0
	KANDAHAR	4.5	8.4	9.7	77.4	8.8	8.2	13.5	69.6	5.3	7.9	17.9	68.9	0.0	20.0	60.0	20.0
	NIMROZ	0.0	0.0	10.0	90.0	15.0	20.0	0.0	65.0	10.0	10.0	15.0	65.0	0.0	20.0	0.0	80.0
	URUZGAN	9.4	12.5	15.6	62.5	8.8	20.6	17.6	52.9	9.4	43.8	28.1	18.8	0.0	0.0	0.0	0.0
	ZABUL	0.0	15.8	15.8	68.4	15.0	23.8	28.8	32.5	28.2	21.4	28.2	22.3	0.0	0.0	0.0	0.0
Sub-Total		2.9	9.3	13.3	74.4	14.6	18.2	15.0	52.2	15.4	18.5	19.4	46.7	0.0	14.3	28.6	42.9
East	KUNAR	4.0	1.3	4.0	90.7	1.8	7.3	18.2	72.7	1.6	6.3	10.9	81.3	0.0	0.0	0.0	100.0
	LAGHMAN	0.0	0.0	0.0	100.0	3.3	0.0	3.3	93.3	0.0	0.0	14.0	86.0	0.0	0.0	50.0	50.0
	NANGARHAR	0.0	0.0	1.7	98.6	0.0	1.9	5.7	92.4	0.6	2.8	4.5	92.2	0.0	14.3	0.0	85.7
	NURISTAN	0.0	8.3	0.0	91.7	0.0	0.0	7.1	92.9	0.0	14.3	14.3	71.4	0.0	33.3	66.7	0.0
Sub-Total		1.0	0.7	1.7	96.7	0.8	2.7	8.2	88.3	0.6	3.5	8.0	87.9	0.0	14.3	21.4	64.3
Southeast	GHAZNI	0.0	0.0	9.3	90.7	1.5	4.5	17.9	76.1	13.4	11.9	16.4	58.2	0.0	50.0	50.0	0.0
	KHOST	0.0	2.3	9.3	88.4	4.9	21.3	4.9	68.9	4.1	8.2	18.4	69.4	0.0	8.5	19.1	68.1
	PAKTIKA	0.0	5.3	10.5	84.2	1.3	6.5	11.7	80.5	1.6	8.1	27.4	62.9	0.0	33.3	0.0	66.7
	PAKTYA	0.0	1.9	7.5	90.6	10.0	6.0	8.0	76.0	0.0	0.0	15.4	84.6	0.0	0.0	50.0	50.0
Sub-Total		0.0	2.2	9.9	87.9	3.9	9.4	11.0	75.7	5.2	7.4	19.6	67.8	0.0	28.6	28.6	42.9
West	BADGHIS	0.0	8.9	15.6	75.6	0.0	14.0	16.3	69.8	16.1	26.8	21.4	35.7	0.0	0.0	33.3	66.7
	FARAH	0.0	3.5	16.2	80.3	9.6	26.4	20.0	44.0	9.6	17.8	22.2	50.4	0.0	0.0	33.3	66.7
	GHOR	1.5	7.7	21.5	69.2	1.8	5.4	17.9	75.0	5.5	21.8	25.5	47.3	0.0	0.0	0.0	100.0
	HIRAT	0.0	0.6	5.9	93.5	1.2	1.2	8.0	89.5	1.1	8.0	62.6	28.2	0.0	0.0	0.0	100.0
Sub-Total		0.2	3.6	12.8	83.4	3.9	11.4	14.2	70.5	6.4	15.5	39.3	38.8	0.0	0.0	15.4	84.6

Vaccination Status of Non- Polio AFP cases, 6-59 Months (2/2)

REGION	PROVINCE	2019 (% Dose)				2020 (% Dose)				2021 (% Dose)				2022 (% Dose)			
		0	1-3	4-6	7+	0	1-3	4-6	7+	0	1-3	4-6	7+	0	1-3	4-6	7+
Northeast	BAGHLAN	0.0	0.9	9.9	89.2	0.0	3.4	9.2	87.4	1.0	3.1	17.5	78.4	0.0	0.0	0.0	100.0
	KUNDUZ	0.0	1.3	18.7	80.0	1.3	1.3	16.0	81.3	2.7	9.6	31.5	56.2	0.0	0.0	0.0	100.0
	TAKHAR	0.0	0.8	3.3	95.9	0.0	0.0	9.0	91.0	1.4	2.9	8.7	87.0	0.0	0.0	0.0	100.0
Sub-Total		0.0	1.0	9.4	89.6	0.4	1.5	11.0	87.2	1.7	5.0	19.2	74.1	0.0	0.0	0.0	100.0
Badakshan		2.6	5.3	0.0	92.1	2.1	4.2	4.2	89.6	2.0	3.9	9.8	84.3	0.0	0.0	0.0	100.0
Central	BAMYAN	0.0	0.0	4.9	95.1	0.0	0.0	2.0	98.0	0.0	1.6	6.3	92.1	0.0	0.0	0.0	0.0
	DAYKUNDI	0.0	0.0	0.0	100.0	0.0	0.0	7.1	92.9	3.4	0.0	13.8	82.8	0.0	0.0	0.0	0.0
	KABUL	0.0	0.6	0.6	98.9	0.5	1.0	1.5	97.0	0.5	0.5	2.7	96.4	0.0	0.0	0.0	100.0
	KAPISA	0.0	0.0	3.4	96.6	0.0	0.0	4.0	96.0	0.0	0.0	13.8	86.2	0.0	0.0	0.0	100.0
	LOGAR	0.0	0.0	3.6	96.4	0.0	8.3	25.0	66.7	3.4	13.8	20.7	62.1	0.0	0.0	0.0	100.0
	PANJSHER	0.0	0.0	0.0	100.0	0.0	0.0	0.0	100	0.0	0.0	0.0	100.0	0.0	0.0	0.0	0.0
	PARWAN	0.0	0.0	2.6	97.4	0.0	2.1	10.6	87.2	0.0	0.0	10.5	89.5	0.0	0.0	0.0	100.0
	WARDAK	0.0	20.0	13.3	66.7	2.0	3.9	25.5	68.6	4.8	12.7	27.0	55.6	0.0	0.0	0.0	100.0
Sub-Total		0.0	1.8	2.6	95.5	0.5	1.6	7.2	90.7	1.2	2.8	9.3	86.7	0.0	0.0	0.0	0.0
North	BALKH	0.0	1.0	6.2	92.8	1.5	4.5	9.0	85.1	1.4	5.6	13.9	79.2	0.0	0.0	0.0	100.0
	FARYAB	0.0	1.8	3.6	94.5	0.0	4.5	11.4	84.1	11.7	5.0	8.3	75.0	0.0	0.0	0.0	100.0
	JAWZJAN	0.0	6.3	18.8	75.0	4.5	6.8	11.4	77.3	2.9	2.9	14.7	79.4	0.0	0.0	0.0	100.0
	SAMANGAN	0.0	4.3	4.3	91.3	0.0	0.0	16.1	83.9	0.0	3.6	21.4	75.0	0.0	0.0	0.0	100.0
	SAR-E-PUL	0.0	0.0	20.0	80.0	0.0	0.0	9.4	90.6	3.3	6.7	6.7	83.3	0.0	0.0	0.0	100.0
Sub-Total		0.0	2.1	8.9	89.0	1.4	3.7	11.0	83.9	4.5	4.9	12.5	78.1	0.0	0.0	0.0	100.0
Country		0.7	3.5	8.5	87.3	4.3	7.6	11.2	76.9	5.8	8.4	14.5	0.71	0.0	9.8	14.6	0.76

AFP Surveillance Indicators by Regions

Region	NP AFP Rate			Stool Adeq %			NPEV %			SL %		
	2019	2020	2021	2019	2020	2021	2019	2020	2021	2019	2020	2021
South	17	21	18	90	86	89	17	20	19	11	5	9
East	26	24	20	95	92	95	17	20	22	8	5	8
Southeast	18	20	15	97	95	96	18	15	17	13	9	10
West	21	20	20	94	93	93	19	18	19	8	5	9
Northeast	21	18	15	94	95	94	16	15	16	5	7	8
Badakhshan	12	12	10	91	89	95	22	17	17	3	7	1
Central	14	15	17	98	98	98	12	16	16	6	6	6
North	15	13	12	92	91	91	16	17	22	5	6	8
Country	18	18	17	94	93	94	16	18	19	8	6	8

ADEQ %

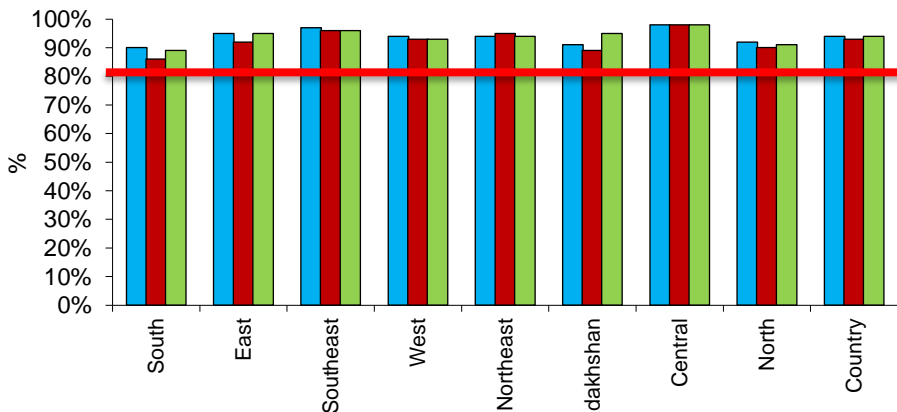

NPEV%

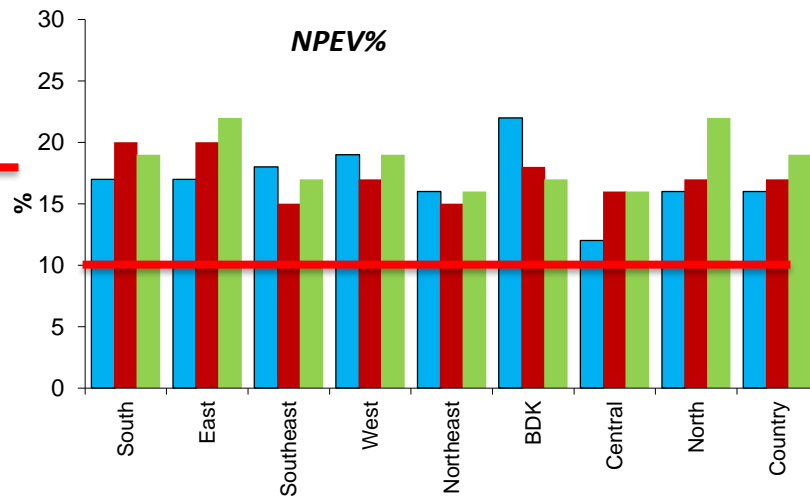

SL%

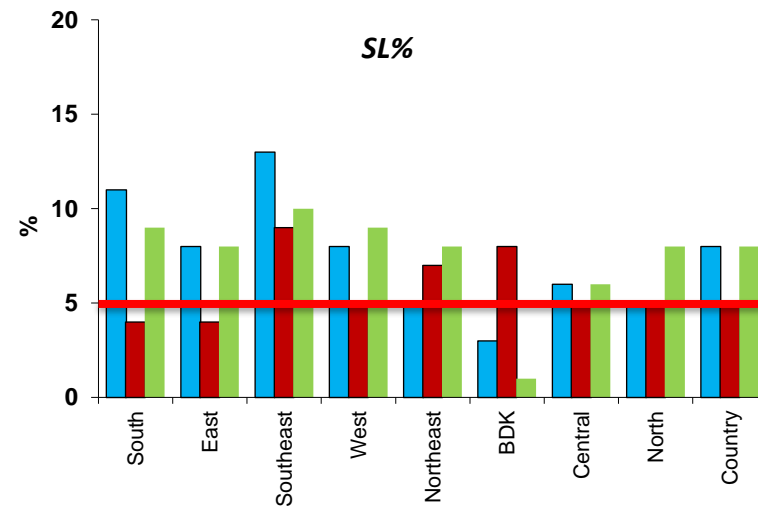

■ 2019 ■ 2020 ■ 2021

Data up to 12 Feb 22

AFP Surveillance Indicators by Regions

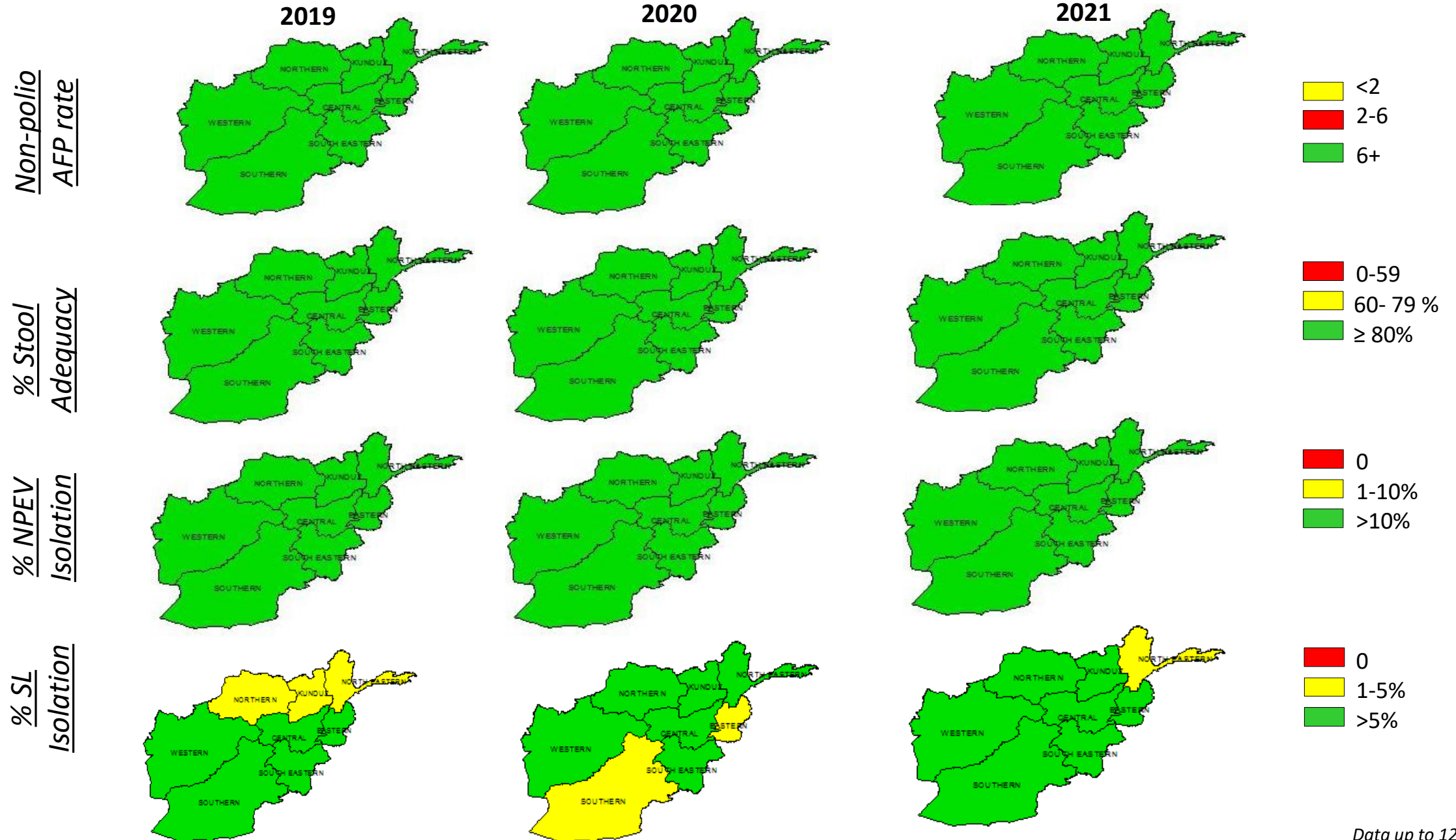

AFP Surveillance Indicators by Provinces													
Region	Province	NP AFP Rate			Stool Adeq %			NPEV %			SL %		
		2019	2020	2021	2019	2020	2021	2019	2020	2021	2019	2020	2021
South	Hilmand	15	15	18	88	84	90	18	23	21	12	4	7
	Kandahar	20	27	23	91	88	88	15	17	16	9	5	12
	Nimroz	17	16	14	97	81	97	13	19	27	3	3	6
	Uruzgan	20	21	15	90	79	92	16	18	23	23	5	17
	Zabul	16	31	38	89	88	88	19	27	20	9	3	6
East	Kunar	37	34	28	95	98	96	20	18	29	8	6	13
	Laghman	17	18	20	94	91	96	19	21	22	2	2	10
	Nangarhar	25	24	23	95	91	95	14	20	19	9	6	7
	Nuristan	24	20	18	88	90	96	35	33	30	4	0	9
Southeast	Ghazni	12	13	12	97	97	95	21	16	16	12	6	15
	Khost	19	22	18	98	96	97	12	14	14	12	4	8
	Paktika	27	32	25	95	95	94	22	14	16	19	17	9
	Paktya	20	20	22	96	96	98	18	17	20	9	10	7
West	Badghis	16	18	19	87	87	90	7	20	22	17	7	15
	Farah	39	34	38	97	93	96	23	20	19	7	3	7
	Ghor	21	18	21	92	94	95	23	19	18	5	9	10
	Hirat	17	17	21	95	95	92	18	16	19	8	5	7
Northeast	Kunduz	17	15	15	95	98	89	14	15	16	5	9	8
	Takhar	19	17	15	95	95	97	17	19	12	5	3	9
	Baghlan	25	21	23	93	93	96	17	12	19	4	8	6
	Badakshan	12	12	12	91	89	95	20	17	17	3	7	1
Central	Kabul	11	12	15	98	99	97	12	15	18	6	4	6
	Kapisa	15	14	18	90	96	96	12	27	14	6	8	13
	Logar	14	13	17	100	100	98	9	19	17	7	5	4
	Parwan	17	22	28	99	96	97	14	20	15	4	5	2
	Wardak	15	22	26	98	100	98	8	10	12	6	5	2
	Panjsher	23	23	26	100	100	100	7	21	20	7	7	0
	Daykundi	14	12	16	98	98	100	11	13	7	6	15	7
	Bamyan	34	36	48	100	99	100	15	17	14	7	9	9
North	Balkh	14	10	11	87	87	89	14	17	23	5	6	7
	Faryab	15	10	14	97	86	88	19	24	27	3	8	12
	Jawzjan	14	19	17	96	97	98	14	12	24	4	5	8
	Samangan	18	21	20	93	94	89	16	17	17	9	4	4
	Sar-e-Pul	13	15	13	93	88	91	15	15	16	4	10	4
Data up to 12 Feb 22													

AFP Surveillance Indicators by Provinces

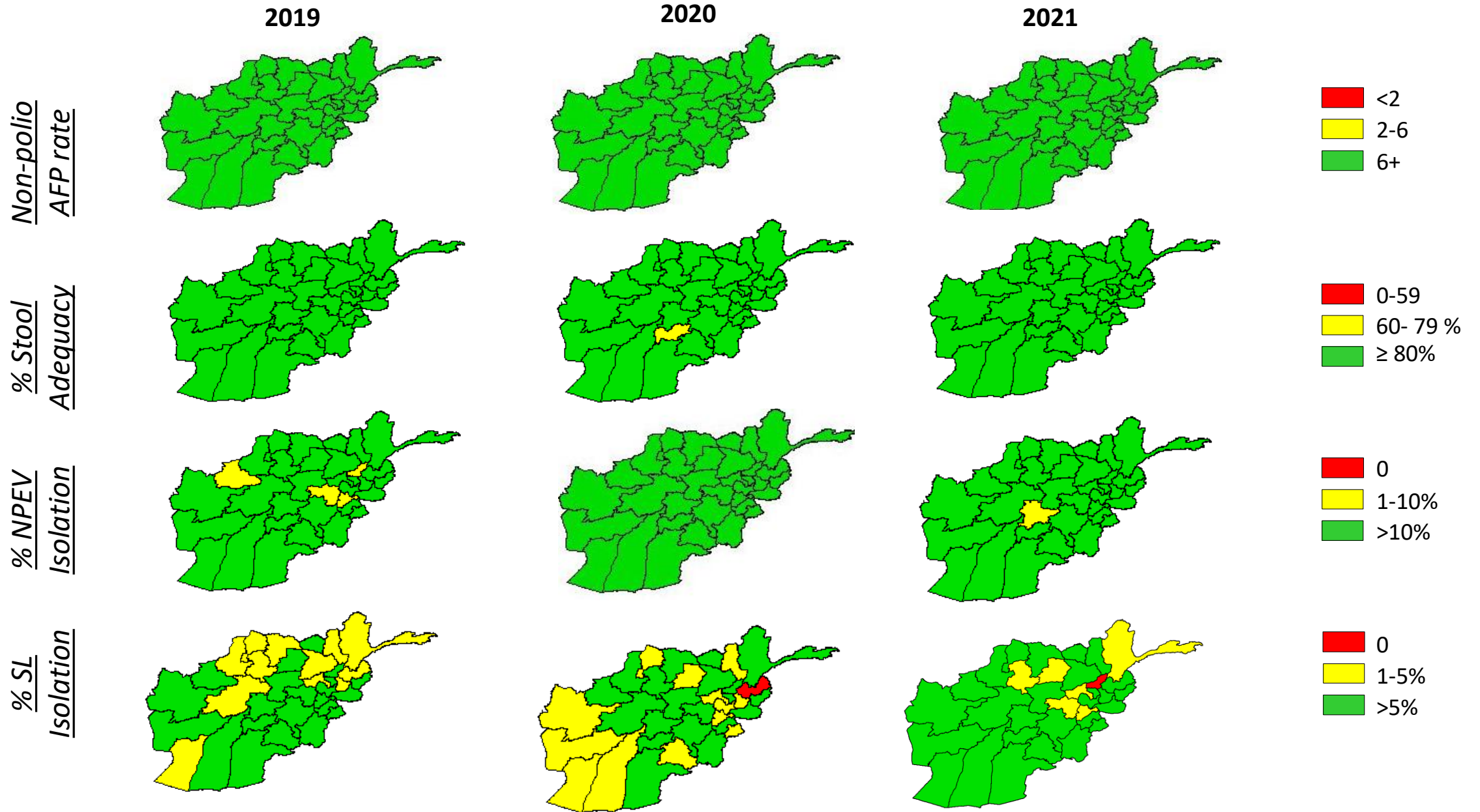

Revised on monthly basis

Data up to 12 F

Surveillance in access compromised areas

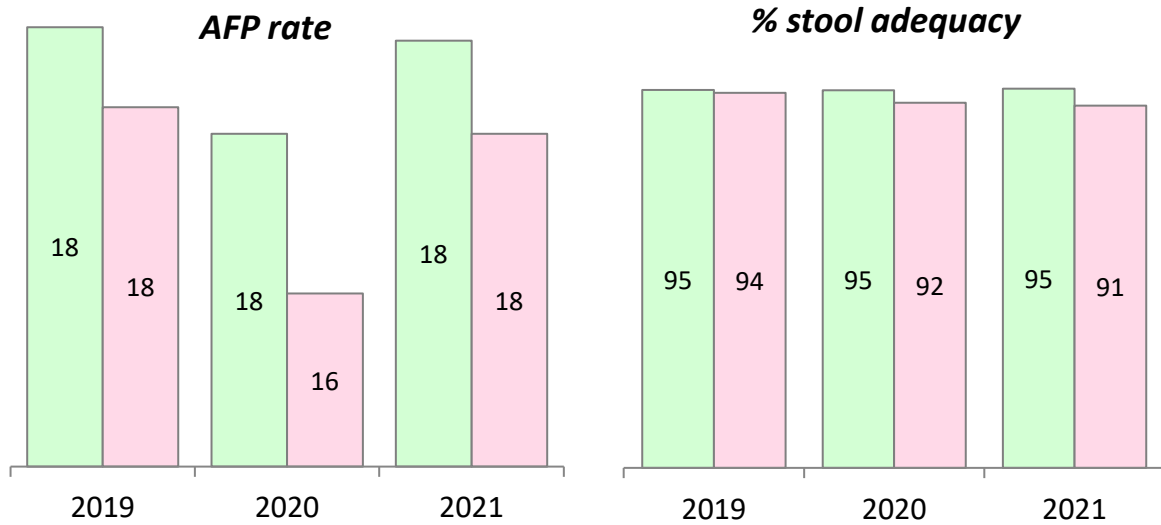

Distribution of AFP cases 2021 vs access

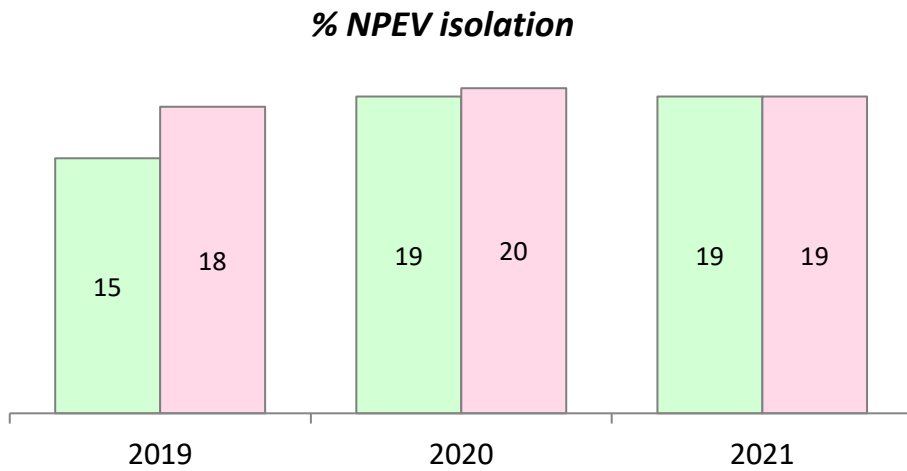
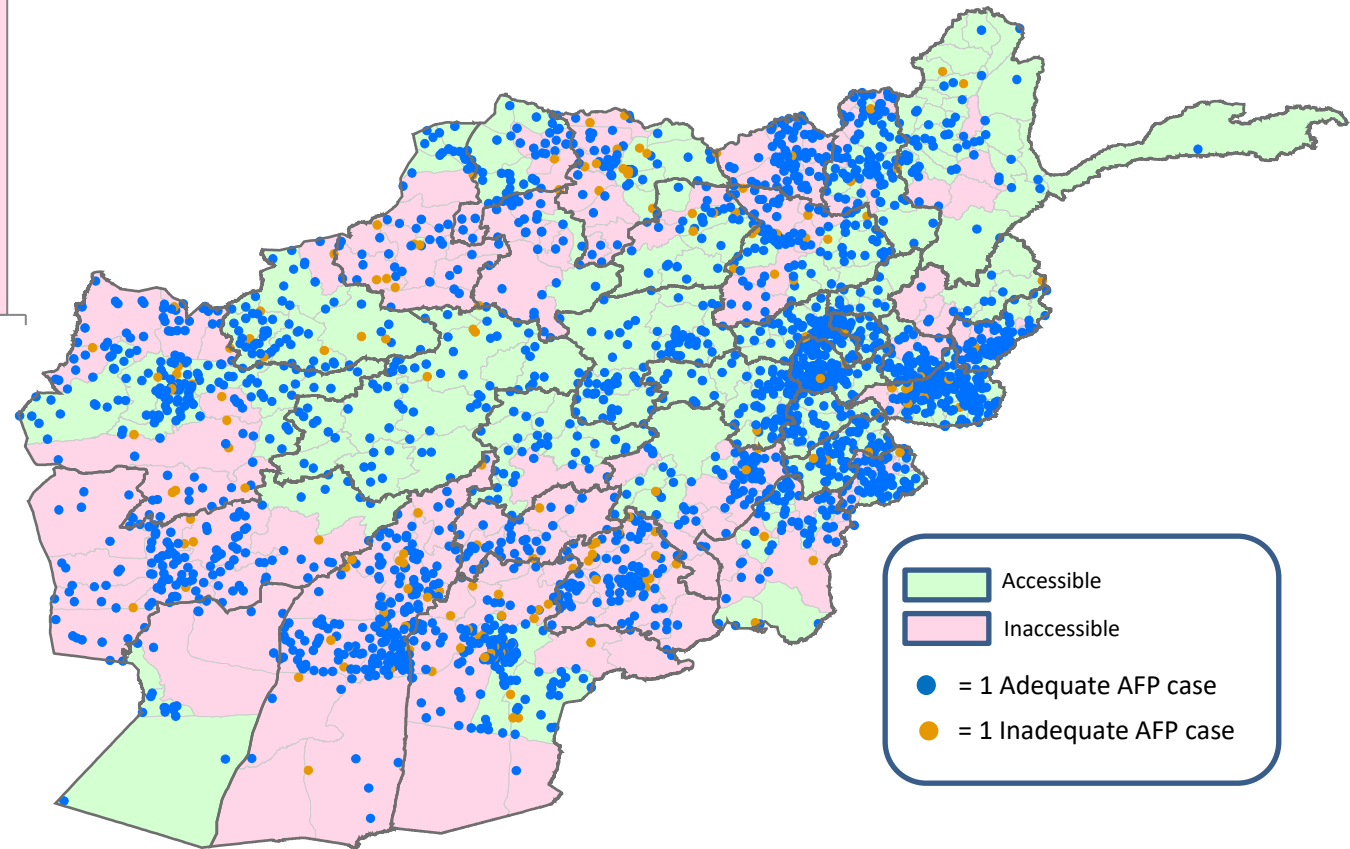

% AFP Cases with Stool Specimen Reaching Lab after 2nd Specimen Collection

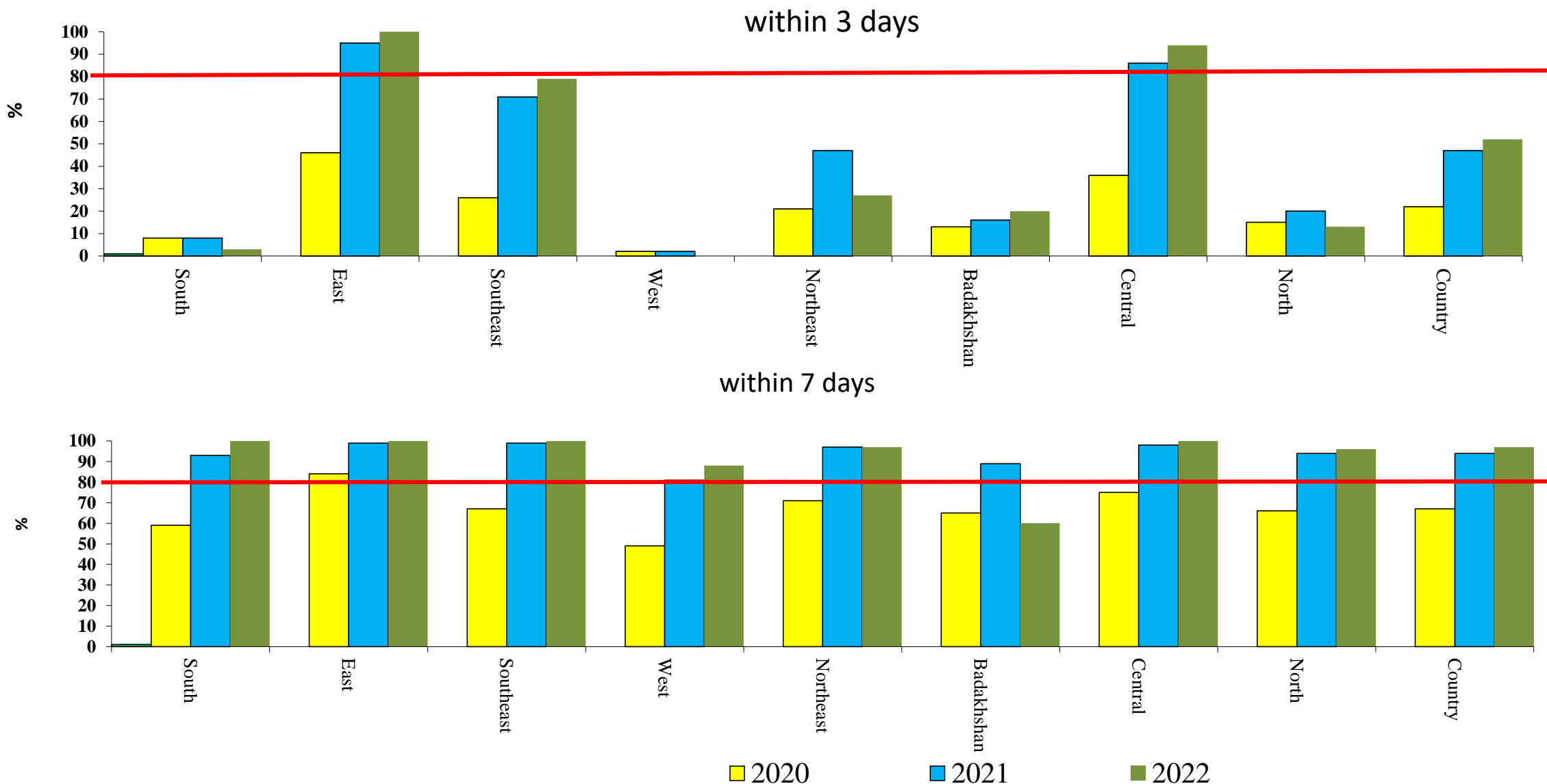

NB. Sample transport disrupted in 2020 due to Torkham border closure/lock down and security issues

Thank You